



3651 N Highway 89 • Chino Valley, AZ 86323  
(928) 636-7080 • www.p-a-g.net

# NISSAN FRONTIER CREW CAB 2WD/4WD 3" BODY LIFT KIT INSTALLATION INSTRUCTIONS 2000 KIT# 40003

## ⚠ WARNING

Installation of a Performance Automotive Group body lift kit will change the vehicle's center of gravity and handling characteristics both on- and off-road. You must drive the vehicle safely! Extreme care must be taken to prevent vehicle rollover or loss of control, which could result in serious injury or death. Avoid sudden sharp turns or abrupt maneuvers and always make sure all vehicle occupants have their seat belts fastened.

## ⚠ WARNING

Before you install this kit, read and understand all instructions, warnings, cautions, and notes in this instruction sheet and in the vehicle owner's manual.

## ⚠ CAUTION

Proper installation of this kit requires knowledge of the factory recommended procedures for removal and installation of original equipment components. We recommend that the factory shop manual and any special tools needed to service your vehicle be on hand during the installation. Installation of this kit without proper knowledge of the factory recommended procedures may affect the performance of these components and the safety of the vehicle. We strongly recommend that a certified mechanic familiar with the installation of similar components install this kit.

## ⚠ WARNING

DO NOT combine suspension, body, or other lift devices. Use of vehicle with combined lifts may result in unsafe and/or unexpected handling characteristics.

## ⚠ WARNING

This kit should only be installed on a vehicle that is in good working condition. Before you install the kit, thoroughly inspect the vehicle for corrosion or deformation of the sheet metal around the factory body mounts. If the vehicle is suspected to have been in a collision or misused, do not install this kit. Off-road use of your vehicle with this kit installed may increase the stress applied to the factory body mounts. We do not recommend that any vehicle with a body lift kit installed be involved in any extreme off-road maneuvers such as jumping. Failure to observe this warning may result in serious personal injury and/or severe damage to your vehicle.

## ⚠ WARNING

Many states and municipalities have laws restricting bumper heights and vehicle lifts. Consult state and local laws to determine if the changes you intend to make to the vehicle comply with the law.

## ⚠ WARNING

The installation of larger tires may reduce the effectiveness of the braking system.

## ⚠ WARNING

Always wear eye protection when operating power tools.

## ⚠ WARNING

Before you install this kit, block the vehicle tires to prevent the vehicle from rolling.

## ⚠ WARNING

Accidental deployment of the air bag can result in serious personal injury or death. To avoid accidental deployment during installation of the kit, the Supplemental Restraint System (SRS, or airbag) must remain deactivated. Do not allow anyone near the airbag during installation. Refer to the factory service manual or owner's manual for the recommended procedure to disable the SRS. After you install the kit, reactivate the SRS before driving the vehicle.

## NOTE

Performance Automotive Group recommends using the Loctite® supplied in the kit on the threads of all kit nuts and bolts unless specified otherwise in these instructions.

## A. Before you start.

### NOTE

As you read through this procedure, note that each part referenced has the same callout number throughout. Also, the part number in the text matches the corresponding part number in the art. Kit parts are prefaced by the word *kit* in italics.

1. Read all warnings and instructions completely and carefully before you begin.
2. Check to make sure the kit is complete (refer to the Parts List, section E).
3. Only install this kit on the vehicle for which it is intended. If anytime during the installation you encounter something different from what is outlined in the instructions, call technical support at (928) 636-7080.
4. Park the vehicle on a clean, dry, flat, level surface and block the tires so the vehicle cannot roll in either direction.
5. Disconnect both battery cables. Disconnect the negative cable (1) first, then the positive cable (2). Remove battery (3) from vehicle (refer to the owner's manual).

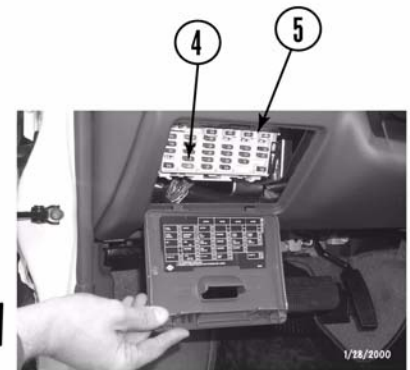
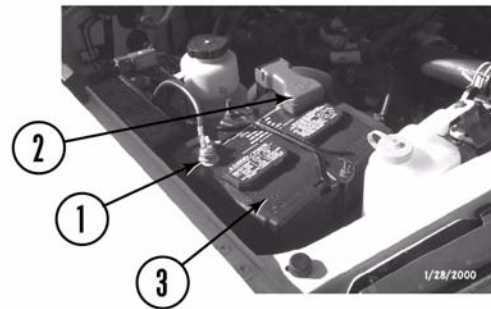

### WARNING

Accidental deployment of the air bag can result in serious personal injury or death. To avoid accidental deployment during installation of the lift kit, the Supplemental Restraint System (SRS, or airbag) must remain deactivated. Do not allow anyone near the airbag during installation. Refer to the factory service manual or owner's manual for the recommended procedure to disable the SRS. After kit installation, the SRS must be reactivated before driving the vehicle.

6. Remove the air bag fuse (4) from the fuse box (5) (see the owner's manual for fuse location).

## B. Get ready to install the kit.

1. Remove the air cleaner assembly.
  - a. Cut zip tie (6).
  - b. Loosen four clips (7).
  - c. Tag, mark, and remove vacuum line (8) from air duct (9).
  - d. Loosen four clamps (10, 11 and 12) and remove the air duct (9) and air cleaner (13) from the throttle body (14) and the intake (15).

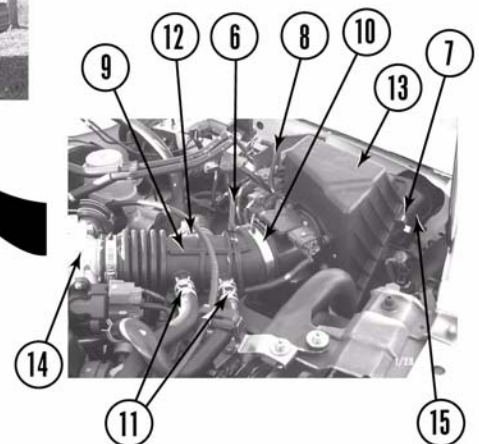

**⚠ CAUTION**

If the following step is not performed, the airbag clock-spring could be damaged. Do not turn the steering wheel while the steering shaft is disconnected.

2. Remove the steering shaft.
  - a. To ensure proper steering alignment when *kit* steering extension is installed, mark the steering shaft (16) where it slides into the upper coupler (17).
  - b. Mark the lower coupler (18) and gearbox (19) where the steering shaft (16) slides onto gearbox splined shaft (20).
3. Remove bolt (21) from the steering shaft (16) and the upper coupler (17).
4. Remove bolt (22) from the steering shaft (16) and the gearbox splined shaft (20).
5. Slide the steering shaft (16) up and off the gearbox splined shaft (20), then down and out of the upper coupler (17). Remove the steering shaft (16) from the vehicle.

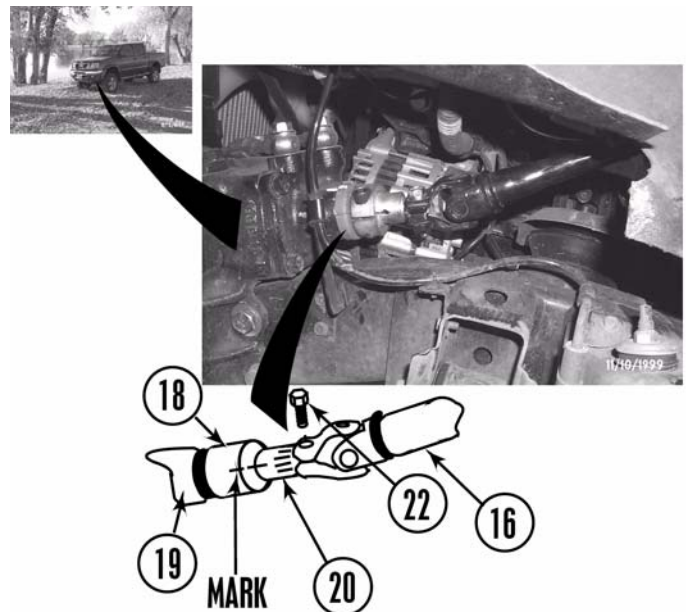
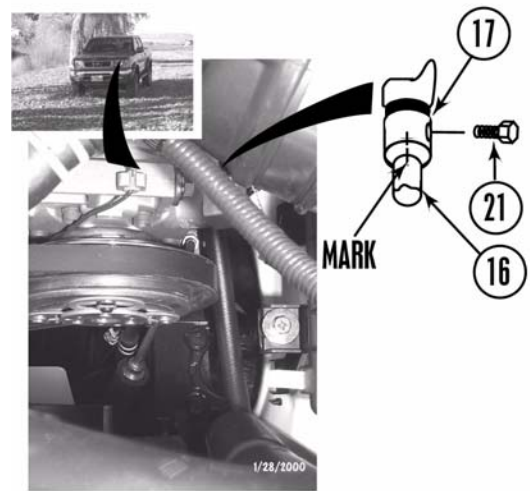

**⚠ WARNING**

If the engine cooling system is hot, the coolant will be HOT and UNDER PRESSURE. To prevent serious personal injury, wait until the cooling system is completely cool before removing the cap from the radiator.

Coolant contains antifreeze. Store drained coolant away from children and animals. Coolant can be fatal if swallowed.

Do not spill coolant while draining system. Coolant is harmful to the environment.

6. Remove the radiator.
  - a. Remove six panel clips (23) and rubber flap (24) from frame (25).
  - b. If present on your vehicle, remove six bolts (26), two panel clips (27), and skid plate (28) from frame (25). If not present go to step A. 6. c. below.
  - c. Ensure radiator (29) has cooled enough to safely open the cooling system. Completely drain radiator into a clean container (refer to the owner's manual).
  - d. Loosen clamp (30) and remove the lower radiator hose (31) from the radiator (29).
  - e. Loosen clamp (32) and remove the upper radiator hose (33) from the radiator (29).

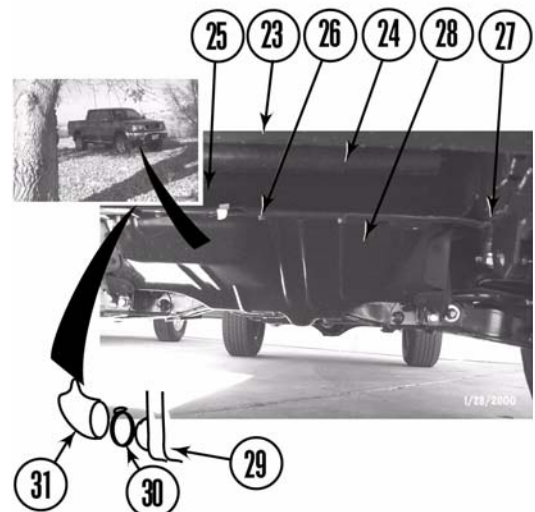

e. Loosen clamp (34), remove two bolts (35) and the overflow bottle (36) from the core support (37).

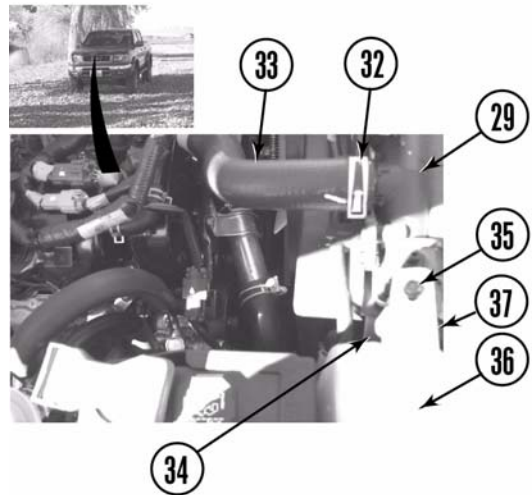

f. Remove screw (38), lockwasher (39), washer (40), and the intake damper (41) from the core support (37).

g. Remove four bolts (42) from the fan shroud (43) and the radiator (29).

h. Remove two locknuts (44) and the two top radiator mounts (45) from the core support (37).

i. Lay fan shroud (43) against the engine and remove the radiator (29) up and out of the lower radiator support (46).

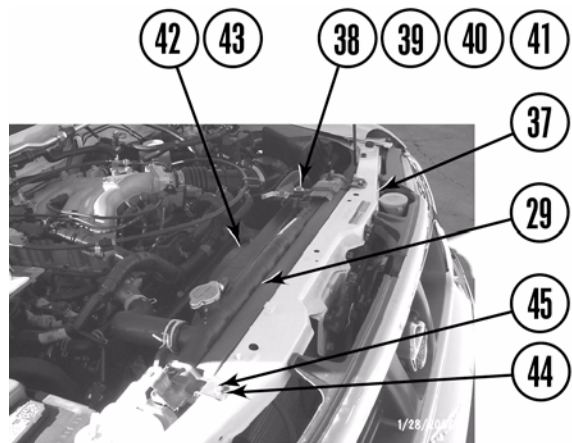

7. Loosen two clamps (47) and remove the heater hoses (48) from the heater core (49) to permit lifting.

8. Remove two bolts (50) and position the a/c hose (51) away from the firewall (52).

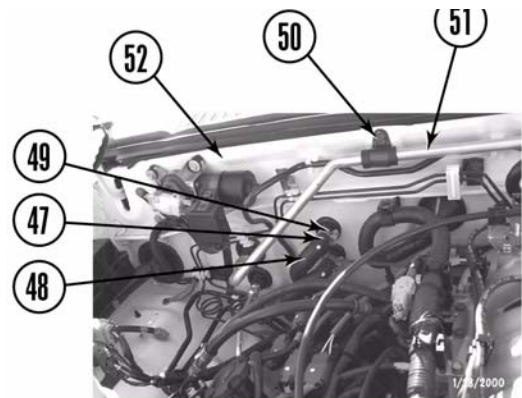

9. Reposition the power steering reservoir.

a. Remove three bolts (53), six washers (54) three grommets (55), bracket (56), and the power steering reservoir (57) from the passenger side front wheel well (58).

b. Install *kit* extension bracket (59) on the wheel well (58) with three grommets (55), six washers (54), and three bolts (53).

c. Install bracket (56) and power steering reservoir (57) on *kit* extension bracket (59) with three *kit* 1/4" x 1" bolts (60), six *kit* 1/4" washers (61), and three *kit* 1/4" nylock nuts (62).

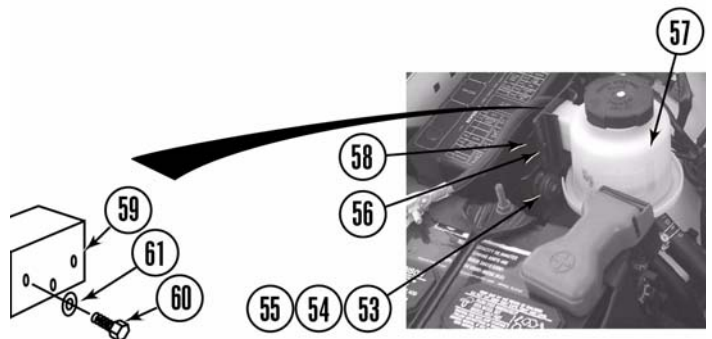

10. Remove the brake lines and vacuum lines.

- a. Remove two screws (63) and the line guard (64) from the passenger side frame rail (25).
- b. Draw a brake line diagram to ensure proper reconnection after the *kit* is installed.
- c. Remove four screws (65), brackets (66), the brake line (67) and the three vacuum lines (68) from the passenger side frame rail (25).
- d. Check along the passenger side frame rail (25) and inside the engine compartment to ensure there is enough slack to allow lifting. Disconnect the lines as necessary.

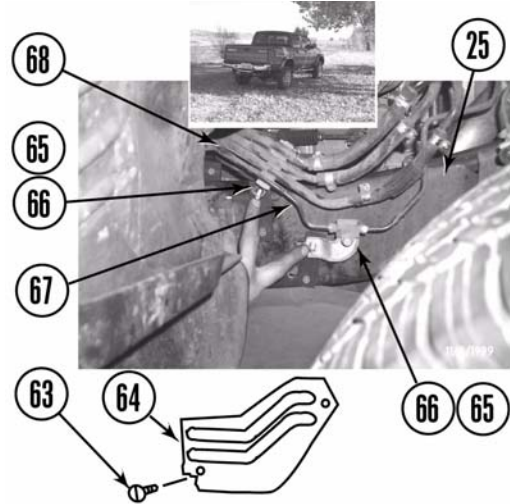

11. Remove two bolts (69), washers (70), and the cab safety loop (71) from the floorboard (72).

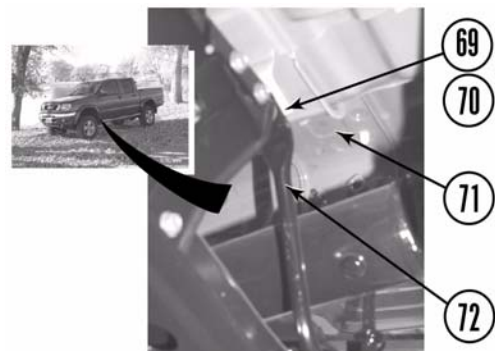

12. Remove the front bumper.

- a. If present on your vehicle, disconnect two wire harness connectors (73) from the driving lights (74).



- b. Remove two bolts (75) and separate the two front bumper supports (76) from the frame (25).

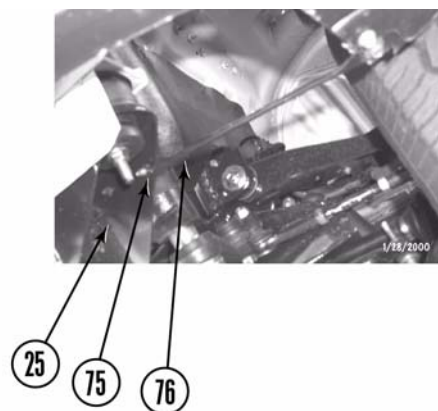

c. Remove two bolts (77) from the front bumper (78) and the front fenders (79).

d. Remove four bolts (80) and the front bumper (78) from the frame (25).

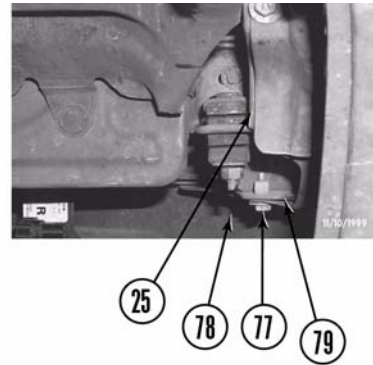

13. Remove four panel clips (81) and separate two wheel well flaps (82) from the frame (25).

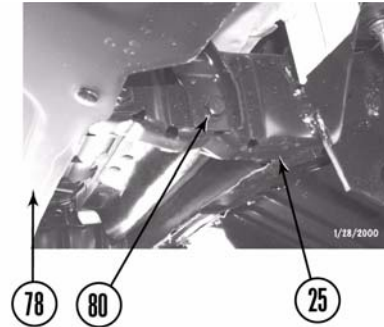

14. Remove transmission and transfer case shift levers.

**NOTE**  
If the vehicle has a manual transmission, ensure transmission is in neutral.

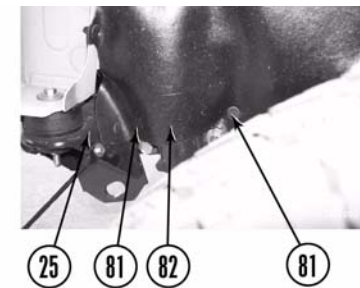

a. Remove 12 screws (83) and four scuff plates (84) from the door jambs (85) on both sides of the body (86).

b. Remove two bolts (87) and pop kick panels (88) from floorboard (72).

c. Remove four screws (89) and the console cover (90) from the floorboard (72). Pull the shift boot (91) back to expose the top of the transmission (92).

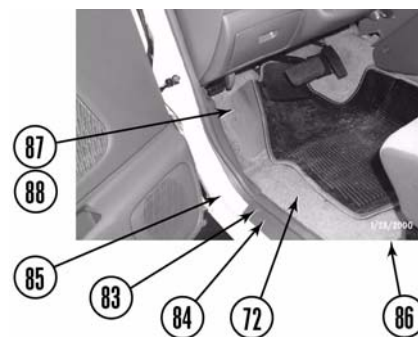

**NOTE**  
Wrap rags around the transmission shift lever base and the transfer case shift lever base immediately after unbolting to avoid dripping transmission fluid on vehicle carpet.

d. Remove c-clip (93), spacer (94), and the transmission shift lever (95) from the transmission (92).

e. Remove bolt (96) and the transfer case shift lever (97) from the transfer case (98).

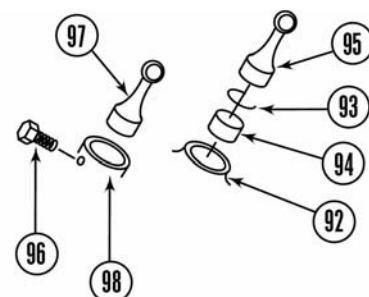

15. Remove fuel filler.

**⚠WARNING**

Use extreme caution when working near fuel lines and fuel tank. Clean up spilled fuel immediately. Any spark could cause an explosion or fire resulting in serious personal injury, death, and damage to the vehicle.

- a. Remove three screws (99) from the fuel filler neck (100) and the bed (101).
- b. Remove three screws (102) and the filler hose guard (103) from the bed (101).

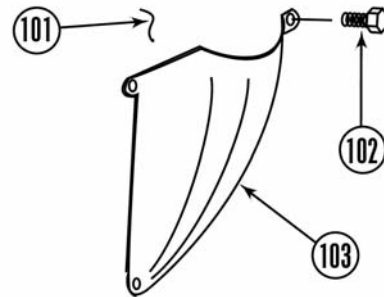
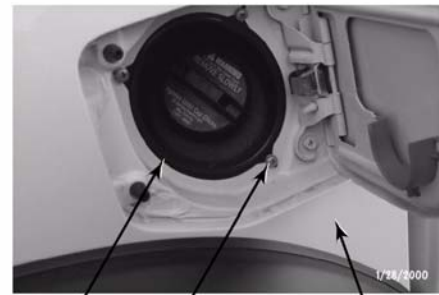

16. Remove the rear bumper.

- a. Disconnect two license plate lights (104) from the rear bumper (105).

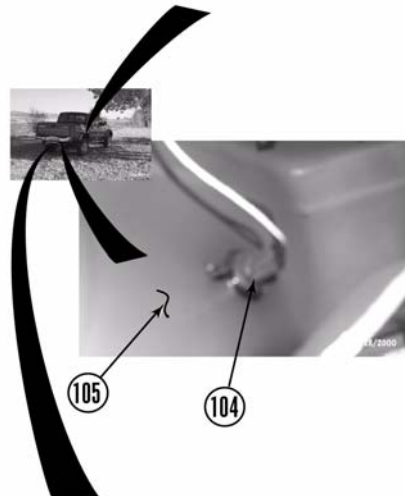

- b. Remove six nuts (106), bolts (107), lockwashers (108), two rear bumper brackets (109), and rear bumper (105) from the frame (25).

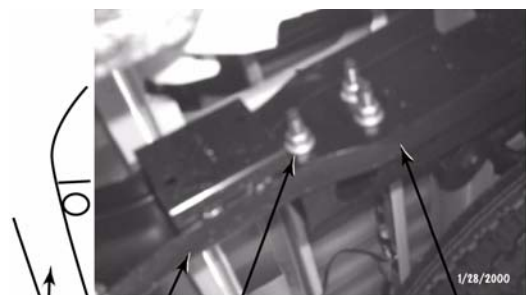

17. Prepare to lift cab from frame.

- a. Remove two bolts (110) and rear seat base (111) from floorboard (72).
- b. Pull the carpet and mat back to expose the two body mounting bolt access covers (112). Remove the access covers from the floorboard (72) and discard access covers.

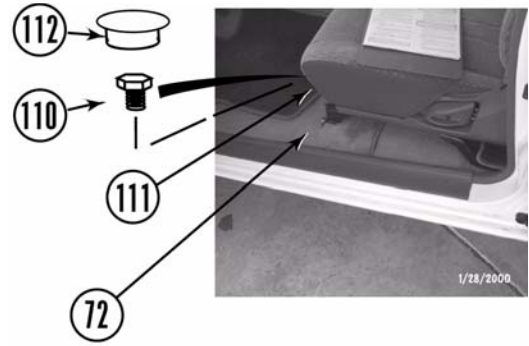

18. Lift the cab.

- a. Measure distance between the cab (86) and the bed (101). Record measurement for later cab to bed alignment reference in the instructions.
- b. Remove four bolts (113) and two outside support brackets (114) from the cab (86) and the frame (25).
- c. Loosen but do not remove eight cab mounting bolts (115) and two nuts (116).

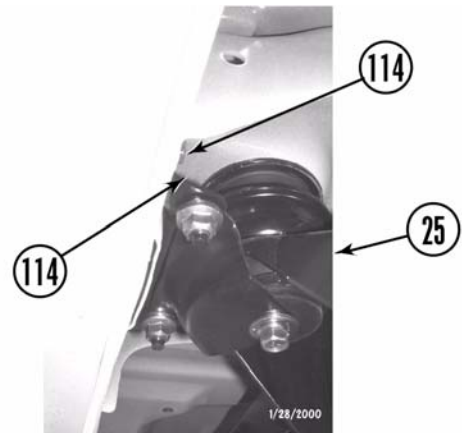
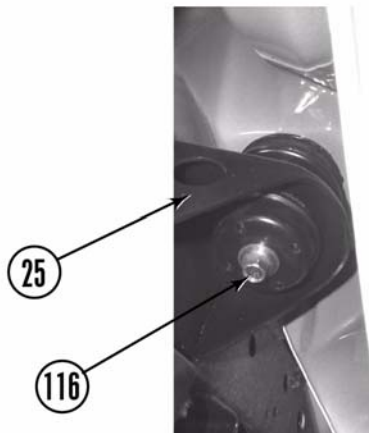
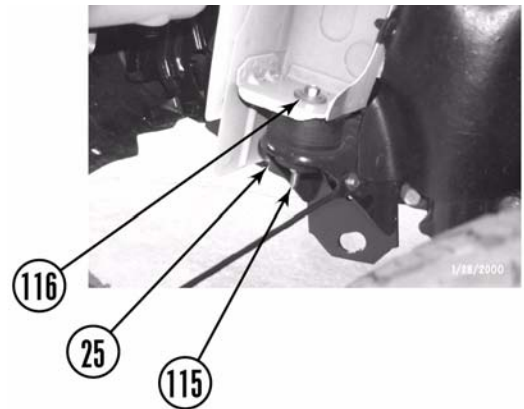
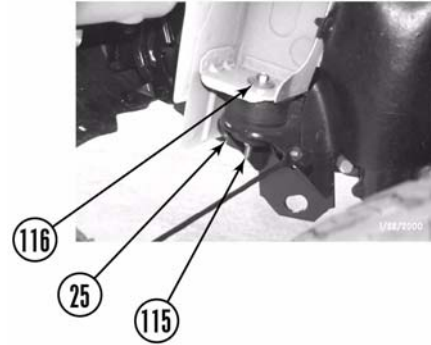



## C. Install the kit.

### ⚠WARNING

Failure to replace the OEM body mounting hardware (except mounting bolts in the kit) in the stock locations could result in serious personal injury or damage to the vehicle.

1. Install the cab passenger side spacer blocks.

### ⚠WARNING

Use extreme caution when lifting cab from frame. Ensure lifting device is securely placed. Keep hands out from between frame and cab, or serious personal injury could result.

### ⚠CAUTION

Continually check hoses, wires, etc. to be sure that everything is flexing properly and not binding, or damage to the vehicle could result. Be especially careful of the a/c hose at the firewall and at the core support.

### ⚠NOTE

Ensure stock spacers and body mounting pads stay on vehicle unless otherwise specified in these instructions. Kit spacer blocks are installed in addition to the stock spacers and body mounting pads.

- a. Remove nut (115), bolt (116), and washer (117) from the core support frame mounting pads (118).
- b. Remove three nuts (115), bolts (116), and washers (117) from the floorboard (72) and frame mounting pads (118). Outside support bracket (114) will come off with middle bolt (116).
- c. Using a hydraulic jack and a wooden block, slowly lift the cab (86) passenger side just high enough to position the *kit* spacer blocks (119) on the frame mounting pads (118).
- d. Position four *kit* spacer blocks (119) on top of the passenger side core support frame and floorboard mounting pads (118).
- e. Install a *kit* 7/16" x 7" bolt (120), a *kit* 3/8" washer (121), and a *kit* 7/16" nylock nut (122) in the core support mounting pad (118). Do not tighten.
- f. Install a *kit* 7/16" x 7" bolt (120), a *kit* 3/8" washer (121), and a *kit* 7/16" nylock nut (122) in the next mounting pad (118). Do not tighten.
- g. Install a *kit* 10mm x 190mm bolt (123), a *kit* 3/8" washer (121), an outside support bracket (114) with the middle bolt, and a *kit* 10mm nylock nut (124) in each of the remaining two mounting pads (118). Do not tighten.

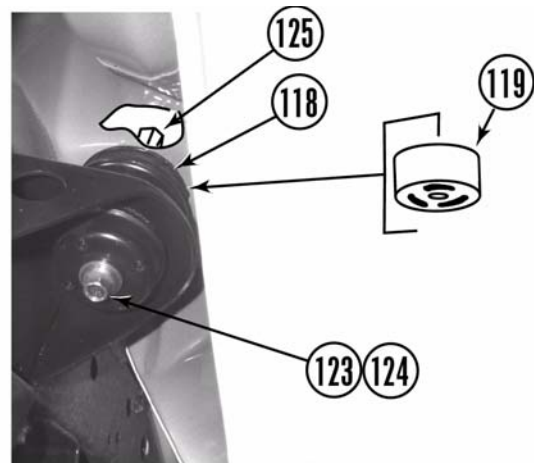
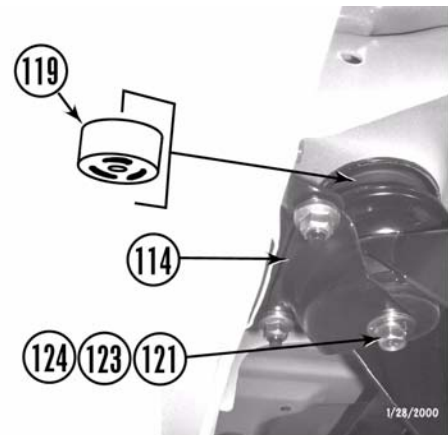
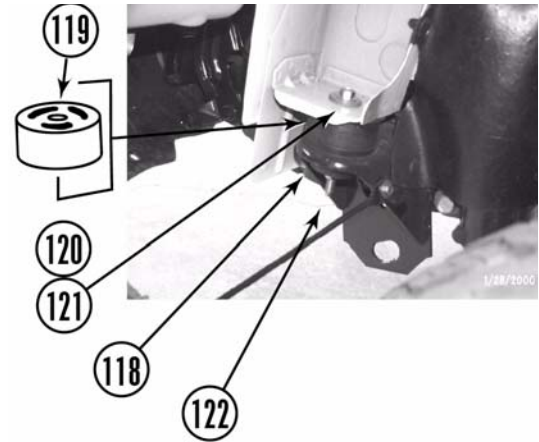

h. Install a *kit* 12mm x 210mm bolt (125) and a *kit* 3/8" washer (121) in the last mounting pad (118). Do not tighten.

i. Install a *kit* outside support extension bracket (126) on the cab (86) with two bolts (113).

Lower the cab (86) on the *kit* spacer blocks.

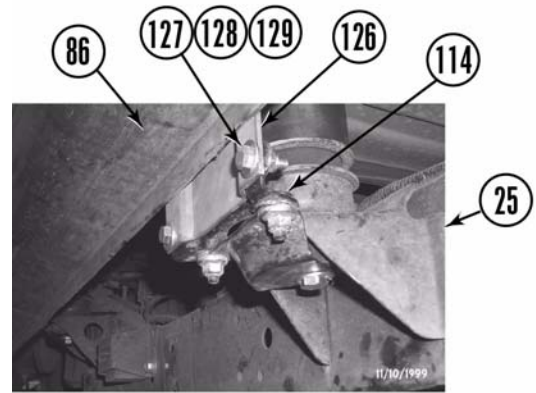

2. Install the cab driver's side spacer blocks.

a. Repeat steps C. 1. a. through j. for the cab driver's side.

3. Finish the cab spacer block installation.

a. Adjust cab to bed clearance using the measurements from step B. 14. a.

b. Install two *kit* outside support extension brackets (126) on the stock outside support brackets (114) with two *kit* 5/16" x 1" bolts (127), four *kit* 5/16" SAE washers (128), and two *kit* 5/16" nylock nuts (129) on each side of the cab (86) and the frame (25). Tighten to 19 lb-ft.

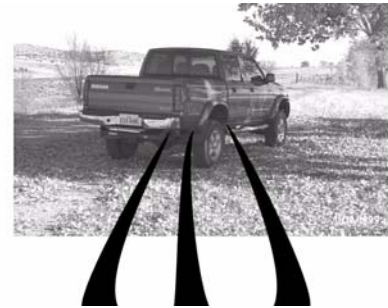

c. Remove eight cab mounting bolts (116, 120, 123, and 125) one at a time, coat threads with Loctite®, and reinstall. Tighten to 55 lb-ft.

4. Install the bed passenger side spacer blocks.

a. Loosen but do not remove four bed mounting nuts (130) and six bolts (131).

b. Remove two mounting nuts (130), three bolts (131), and washers (132) from the bed (101) passenger side.

c. Using a hydraulic jack and a wooden block, slowly lift the bed (101) passenger side just high enough to position the *kit* spacer blocks (133 and 134) on the frame (25).

d. Install mounting bolt (131), washer (132), and *kit* spacer block (133) in the bed passenger side front frame mounting pad (118). Do not tighten.

e. Install three *kit* mounting bolts (135, 136, and 137), two *kit* 1/2" USS (large) washers (138) and *kit* 1/2" nylock nuts (139) in the following positions: 7/16" x 1 1/2" bolt (135) in the *kit* spacer block (133) and the bed passenger side front frame mounting pad (118), 1/2" x 5" bolt (136) in the *kit* spacer block (134) and the bed passenger side middle frame mounting pad (118), and 1/2 x 5 1/2" bolt (137) in the *kit* spacer block (134) and the bed passenger side rear frame mounting pad (118). Do not tighten.

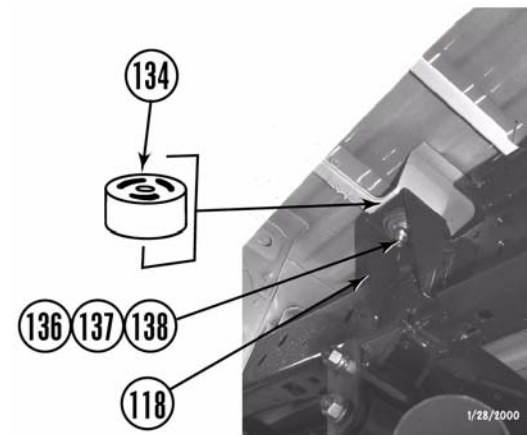
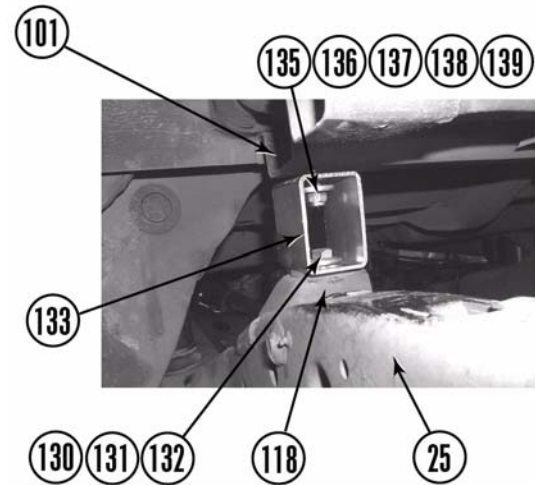

5. Install the bed driver's side spacer blocks.
  - a. Repeat steps C. 4 a. through e. for the bed driver's side.
6. Finish the bed spacer block installation.
  - a. Adjust the cab to bed clearance using the measurements from step B. 18. a.
  - b. Remove eight bed mounting bolts (131, 135, 136, and 137) one at a time, coat threads with Loctite®, and reinstall. Tighten to 85 lb-ft.
7. Install the steering extension.

**⚠WARNING**

Failure to properly install steering extension could result in loss of steering, causing serious personal injury and damage to the vehicle.

a. Install male end of steering extension (140) in the lower coupler (18) of the steering shaft (16). Ensure extension (140) is positioned so the stock retaining bolt (22) will install across the steering extension flat. Install bolt (22) in the steering shaft (16). If bolt (22) will not easily slide across the flat, the extension is incorrectly installed. Do not tighten.

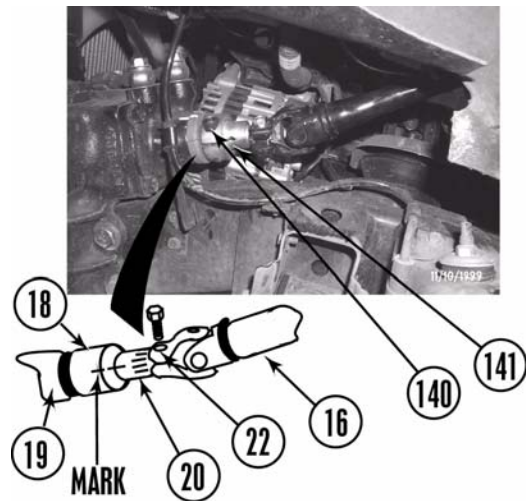

b. Extend the mark on the lower part of the steering shaft (16) down onto the steering extension (140). Install the upper part of the steering shaft (16) in the upper coupler (17). Ensure the marks are aligned.

c. Coat threads of retaining bolts (21, 22, and 141) with Loctite®.

d. Install stock retaining bolt (21) in the upper coupler (17).

e. Align the mark on the steering extension (140) with the mark on the gearbox (19). Install the steering extension on the gearbox splined shaft (20) with the *kit* retaining bolt (141). Do not tighten.

f. Ensure all marks are aligned and there is ample engagement at all unions. Tighten retaining bolts (21, 22, and 141) to 30 lb-ft.

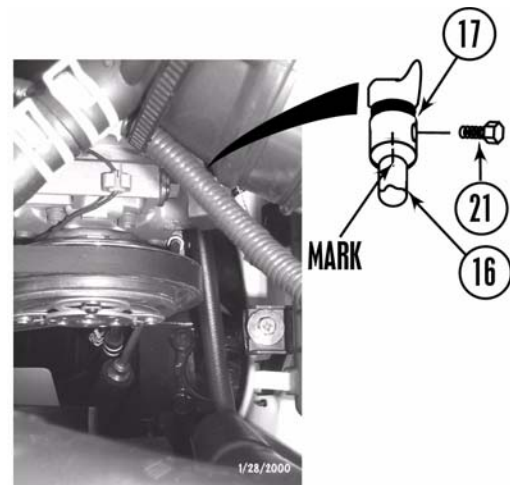

8. Install a/c hose (51) on the firewall (52) with two bolts (50).
9. Install two heater hoses (48) on the heater core (49) and tighten two clamps (47).

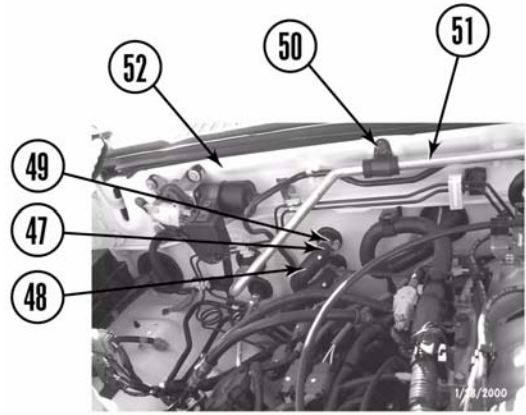

10. Install the brake line and vacuum lines.

a. Refer to the diagram from step A. 10. b. and install the brake line (67) and vacuum lines (68) on the passenger side frame rail (25) with two brackets (66), *kit* brackets (142), two screws (65), and two *kit* nuts (143). Ensure there is ample slack.

b. Install the line guard (64) on the passenger side frame rail (25) with two screws (63).

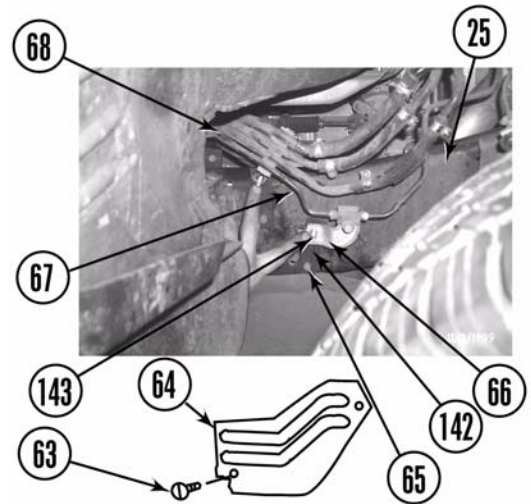

11. Install the radiator.

**NOTE**

After you cut metal away from the lower radiator support, you may want to prime and paint the affected area to avoid the possibility of rust forming.

a. Using a die grinder or hacksaw, cut away the stock lower radiator support (46) from the core support (37). Be especially careful of the a/c condenser (144) when cutting. Cut to the outside of each mounting hole approximately 1 1/2" to 2" and flush with the vertical surface of the core support. Allow enough room for the radiator to slide past the remaining sheet metal.

b. Using *kit* lower radiator support (145) as a template, mark the core support (37) for alignment. Align the holes in *kit* radiator support with the stock mounting holes. Mark the core support for proper alignment after the stock lower radiator support (46) has been removed.

c. Position *kit* lower radiator support (145) on the core support (37). Ensure *kit* support is aligned with the marks and flush against the core support, lip resting on the top.

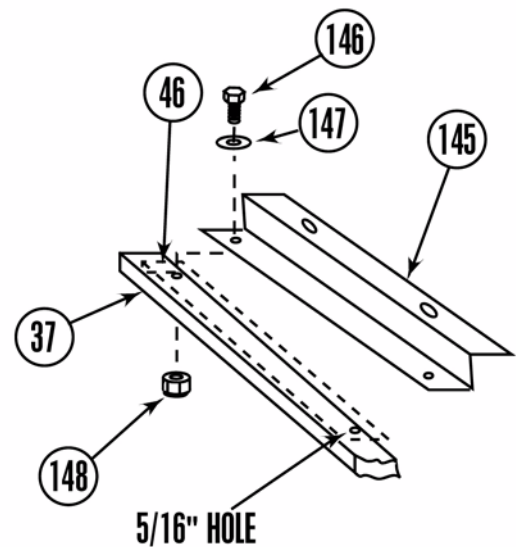

- d. Using the *kit* lower radiator support (145) as a template, mark the top of the core support (37) through the holes and remove.
- e. Drill a 5/16" hole at each mark.
- f. Install *kit* lower radiator support (145) on the core support (37) with two *kit* 1/4" x 1" bolts (146), four *kit* 1/4" washers (147) and two *kit* 1/4" nylock nuts (148). Do not tighten.
- g. Position radiator (29) on the *kit* lower radiator support (145).

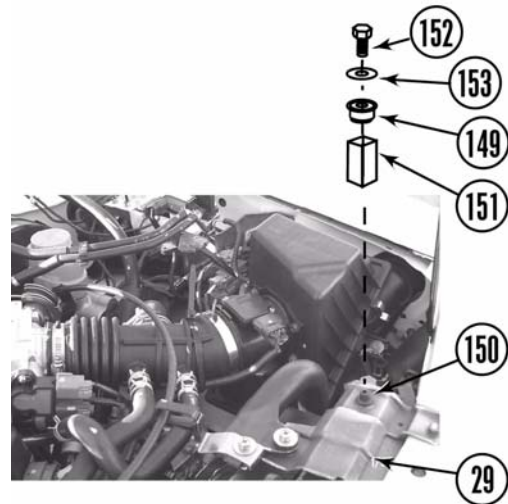

- h. Remove two rubber bushings (149) from the plastic studs (150) on the radiator (29) top.
- i. Position two rubber bushings (149) in the large holes in two *kit* 2" x 3" x 1" spacer with holes (151) and slide the tubes on the plastic studs (150).
- j. Install two top radiator mounts (45) on the *kit* 2" x 3" x 1" spacers with holes (151) with two *kit* 3/8 x 1" bolts (152), *kit* 3/8" USS washers (153), and *kit* 3/8" nylock nuts (154). Do not tighten.

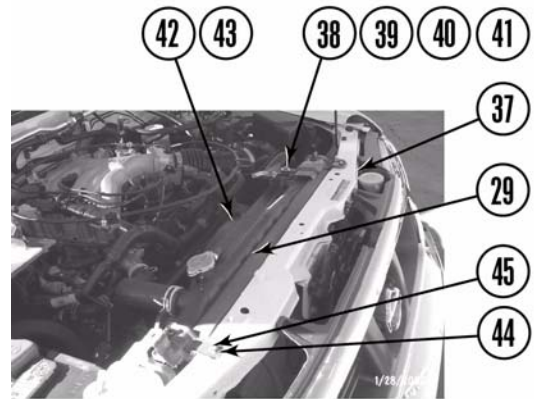

- k. Ensure radiator (29) is secure and tighten all radiator mounting hardware (146 and 148, 152 and 154).
- l. Install two top radiator mounts (45) on the core support (37) with two locknuts (44).
- m. Install fan shroud (43) on the radiator (29) with four bolts (42). Check the fan to fan shroud clearance to ensure fan cannot make contact with the fan shroud.
- n. Install upper radiator hose (33) on the radiator (29) and tighten clamp (32).

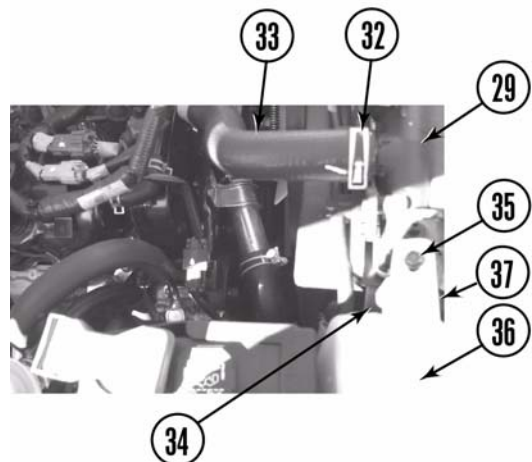

- o. Install overflow bottle (36) on the core support (37) with two bolts (35). Tighten clamp (34).
- p. Install intake damper (41) on the core support (37) with washer (40), lockwasher (39), and screw (38).

q. Bend a/c hose (51) firewall mounting bracket (155) forward to a 45-degree angle. This should give the line ample slack. If the line still feels tight, carefully bend the steel portion of the line to gain more slack.

r. Check the a/c hose (51) at the core support (37). Ensure there is enough slack in the line to install. If not, remove bolt (156) and carefully bend the line. Install the a/c hose on the core support with the bolt.

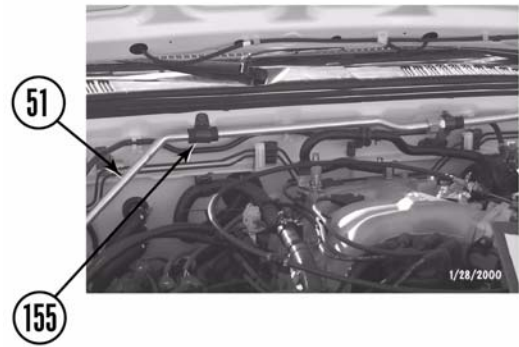

s. Install lower radiator hose (31) on the radiator (29) and tighten clamps (30).

t. Install rubber flap (24) on frame (25) with six panel clips (23).

u. If removed, install skid plate (28) on frame (25) with six screws (26) and panel clips (27).

v. Fill cooling system as much as possible. Radiator (29) must be topped off later after the vehicle has been started.

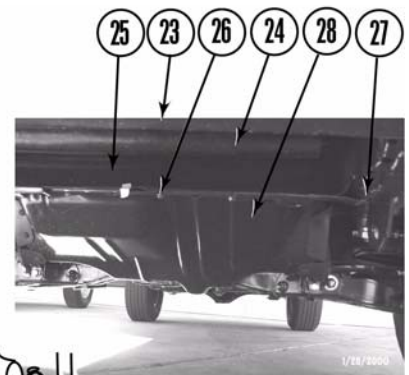

**NOTE**

It may be necessary to bend cab safety loop slightly to align with the floorboard mounting holes.

12. Install the cab safety loop (71) on the floorboard (72) with two kit 3" tubes (157), kit 3/8" washers (158), and kit 10mm x 1.25 x100" bolts (159). Tighten to 30 lb-ft.

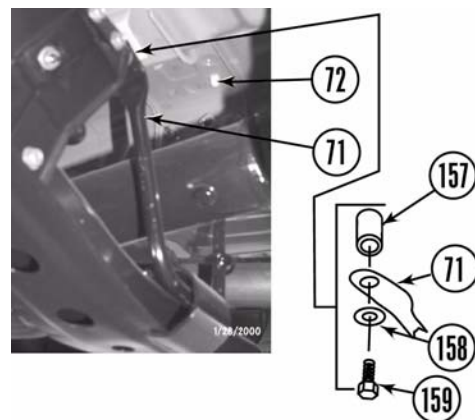

**⚠️WARNING**

Use extreme caution when working near fuel lines and fuel tank. Clean up spilled fuel immediately. Any spark could cause an explosion or fire resulting in serious personal injury, death, and damage to the vehicle.

13. Lengthen and install the fuel filler hose.

- a. Loosen clamp (160) on the filler hose (161) and the fuel tank (162).
- b. Loosen clamp (163) on the vent hose (164) and the fuel tank (162) and remove the filler neck and hose assembly from the bed (101).

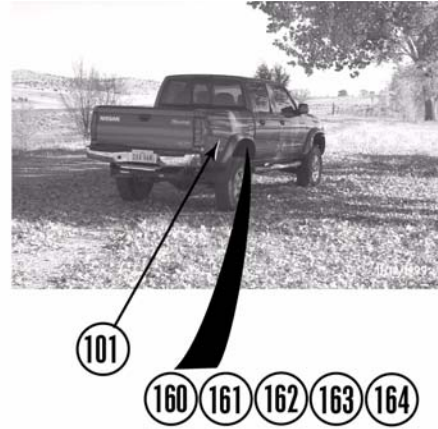

- c. Cut filler hose (161) (toward the bottom below the first bend) as shown.
- d. Install *kit* 1 3/4" fuel filler extension (165) between the two cut sections with two *kit* #28 clamps (166) at each end of the extension.
- e. Remove vent hose (164) from the filler neck (100) and install the *kit* 1/2" x 19" vent hose (167) with a *kit* #10 clamp (168).

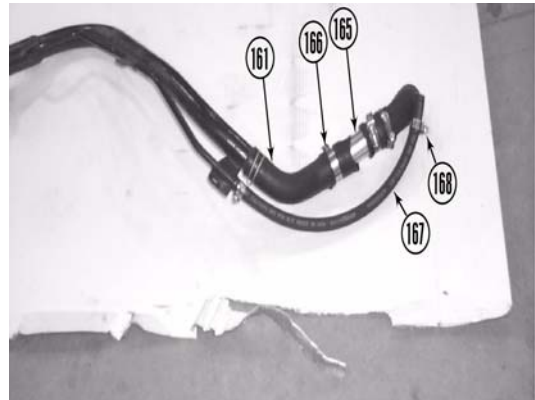

- f. Position filler neck and hose assembly in the bed (101) and install the filler hose (161) on the fuel tank (162) with the clamp (160). Do not tighten.
- g. Install *kit* vent hose (166) on the fuel tank (162) with a *kit* #10 clamp (168). Do not tighten.

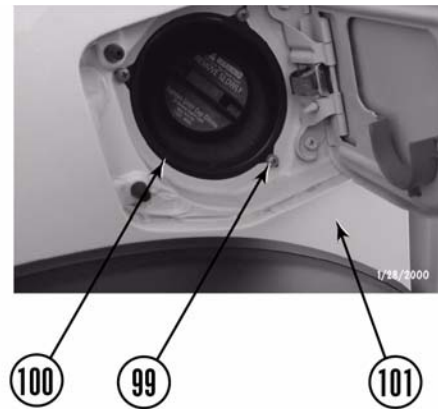

- h. Install filler neck (100) on the bed (101) with three screws (99). Tighten clamps (160, 163, 166, and 167).
- i. Install filler hose guard (103) on the bed (101) with three screws (102).

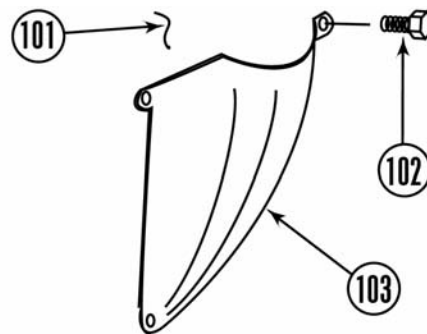

14. Lengthen and install the transmission shift lever and the transfer case shift lever.

a. Scribe a line along the side of the transmission shift lever (95) (below the bend) as shown. Cut the lever into two pieces through the line and deburr as necessary.

b. Position *kit* transmission shift lever extension (168) between the two pieces of the transmission shift lever (95), tapered end toward lever bottom. Ensure lever is all the way in and the extension and lever scribe lines align.

c. Using the holes in the extension as a guide, drill one 1/8" hole through each part of the transmission shift lever (95) and the opposite side of the extension (168).

d. Install two *kit* 1/8" x 1" roll pins (169) in the holes.

e. Scribe a line along the side of the transfer case shift lever (97) (above the two bottom bends) as shown. Cut the lever into two pieces through the line and deburr as necessary.

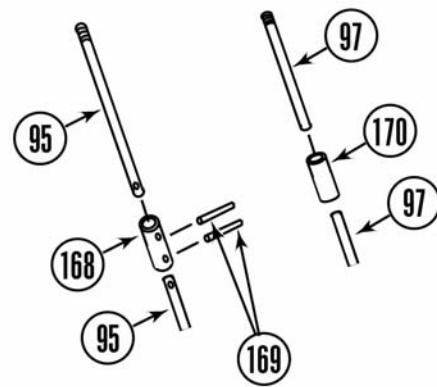

**⚠WARNING**

Be careful not to damage any of the parts attached to the shift levers during cutting and welding or damage to the equipment could result. A certified welder should perform all welding.

f. Position *kit* transfer case shift lever extension (170) between the two pieces of the transfer case shift lever (97). Ensure the extension and lever scribed lines align and weld the extension in place.

g. Position transmission shift lever (95) in the top of the transmission (92). Ensure lever is all the way in and install the spacer (94) and c-clip (93).

h. Install transfer case shift lever (97) on the transfer case (98) with the bolt (96).

i. Check transmission shift lever and transfer case shift lever operation. Ensure there is complete engagement in all gears and ranges. If necessary, adjust the linkage (refer to the factory repair manual).

j. Install the shift boot (91) and console cover (90) on the floorboard (72) with four screws (89). Check transmission shift lever and transfer case shifter operation again.

k. Return the carpet and mat to its original position and install two scuff plates (89) on door jambs (85) with 14 screws (83).

l. Install two kick panels (88) on floorboard (72) with two bolts (87).

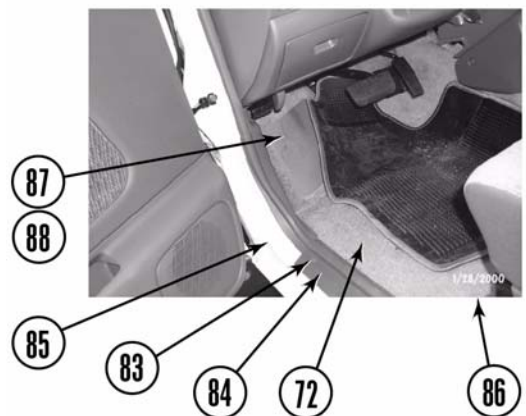
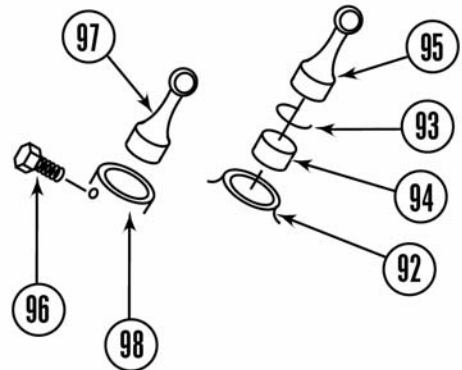



m. Position rear seat base (111) on floorboard (72) and install two bolts (110).

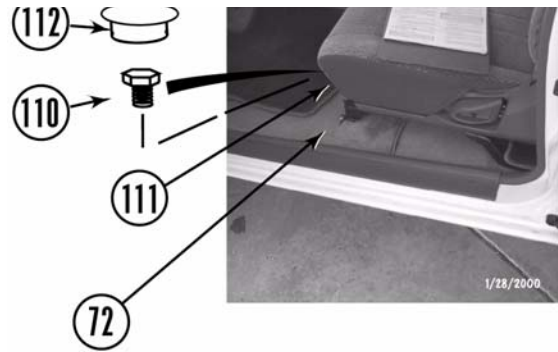

15. Install the front bumper.

a. Coat threads of twelve bolts (75, 77, and 80) and two *kit* 7/16" x 1" bolts (171) with Loctite®.

b. Install two *kit* front bumper relocating brackets (172) on the frame (25) with four bolts (80). Tighten the bolts enough that the brackets cannot move but the front bumper (78) can still be adjusted.

c. Position front bumper (78) on the *kit* relocating brackets (172) and install two *kit* 7/16" x 1" bolts (171), four *kit* 7/16" USS (large) washers (173), and two *kit* 7/16" nylock nuts (174). Do not tighten.

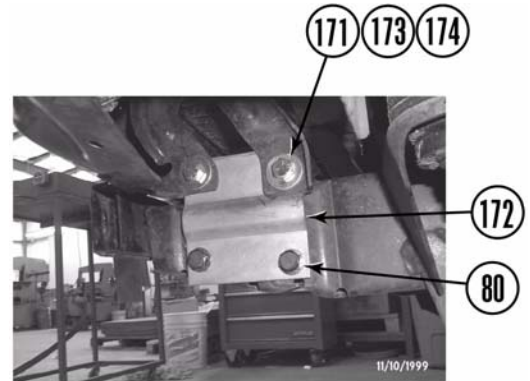

d. Install two bolts (77) in the front bumper (78) and front fenders (79). Do not tighten.

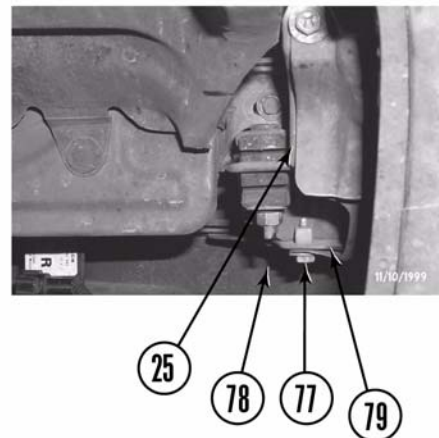

e. Adjust bumper to body clearance and tighten eight bolts (77, 80, and 171) to \* lb-ft.

f. Install two front bumper supports (76) on frame (25) with two bolts (75). Tighten to \* lb-ft.

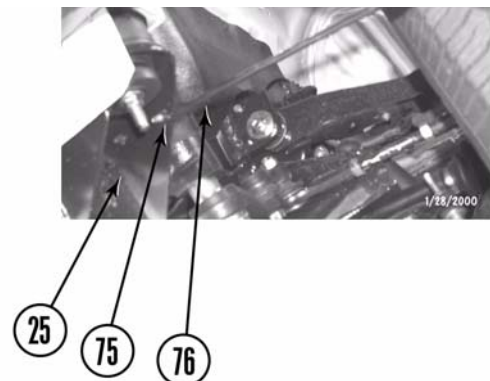

**NOTE**

Wheel well flaps may not reinstall in frame with panel clips. Because of the lift, you may have to reattach with zip ties, or you can call us to order gap guards.

g. Install two wheel well flaps (82) on the frame (25) with four panel clips (81).

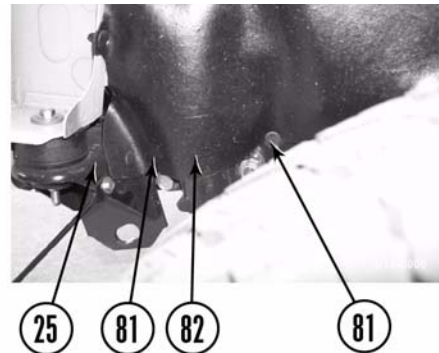

h. If removed, connect two wire harness connectors (73) on the driving lights (74).

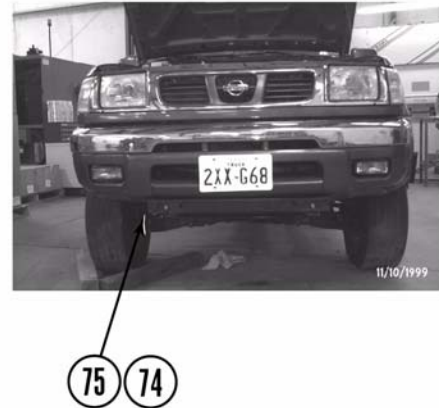

**WARNING**

Raising the rear bumper is intended to enhance the appearance of the vehicle only. When raised, the rear bumper is no longer be rated for towing of any kind. Attempting to tow with the rear bumper after it has been raised can result in damage to the vehicle and possible personal injury. A class III receiver hitch must be installed to tow with the vehicle after the rear bumper has been raised.

16. Install the rear bumper.

- a. Coat threads of six bolts (106) with Loctite®.
- b. If you intend to tow with the rear bumper (105), install two rear bumper brackets (109) and rear bumper on frame (72) with six bolts (107) and nuts (106).

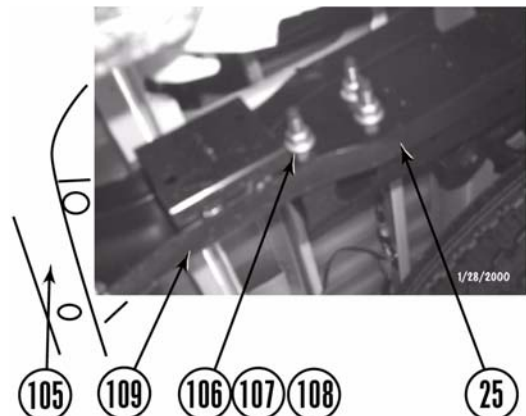

c. To raise rear bumper (105), remove four nuts (175), bolts (176), and two rear bumper brackets (109) from the rear bumper (105).

d. Install two *kit* rear bumper brackets (177) on the frame (25) with six bolts (107), lockwashers (108), and nuts (106). Tighten bolts enough that the brackets cannot move but the rear bumper can still be adjusted.

e. Coat threads of six bolts (176) with Loctite®.

f. Install rear bumper (105) on two *kit* rear bumper brackets (177) with two bolts (176) and nuts (175). Tighten bolts enough that the brackets cannot move but the rear bumper can still be adjusted.

g. Adjust the bumper to body clearance and tighten the bolts (107) and nuts (175) to \* lb-ft.

h. Connect two license plate lights (104) on the rear bumper (105).

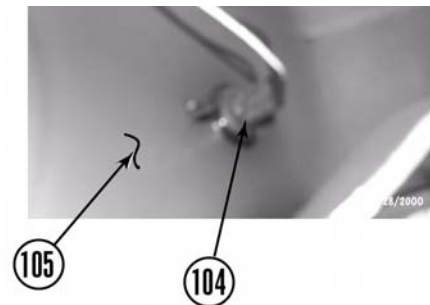
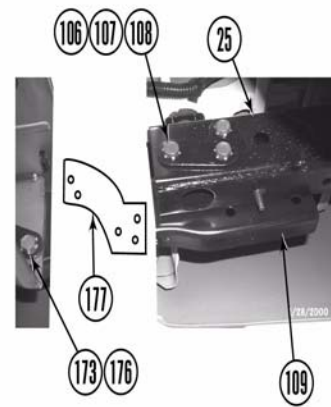

17. Install the air cleaner.

a. Position air cleaner (13) and air duct (9) on throttle body (14) and intake (13) and tighten four clamps (10, 11, and 12).

b. Install vacuum line (8) on air duct (9).

c. Clamp four clips (7).

d. Install *kit* zip tie (6).

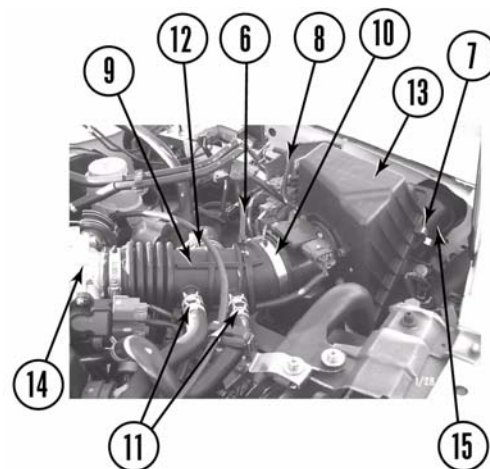

**⚠WARNING**

All welding should be performed by a certified welder.

18. Install four bed overload pads on the frame over the wheel wells.

a. Remove four bolts (178) and rubber pads (179) from the frame (25) and position four *kit* overload pads (180) where the rubber pads were.

b. Tack weld only the four pads (180) to the frame (25).

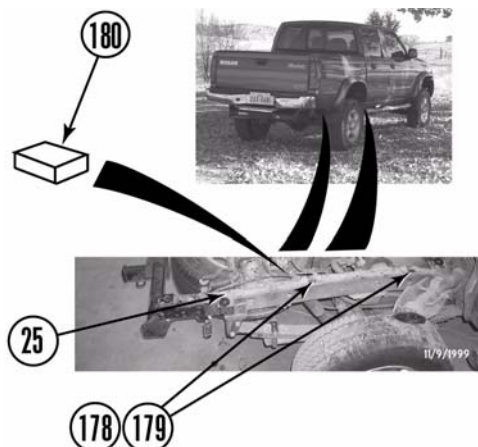

## D. After installation is complete.

1. Install airbag fuse (4) in the fuse box (5).
2. Install battery (3) and connect both battery cables. Be sure to reconnect the positive cable (2) first, then the negative cable (1).
3. Stick *kit* warning sticker on the dash in plain sight of all vehicle occupants.
4. Double check the vehicle.

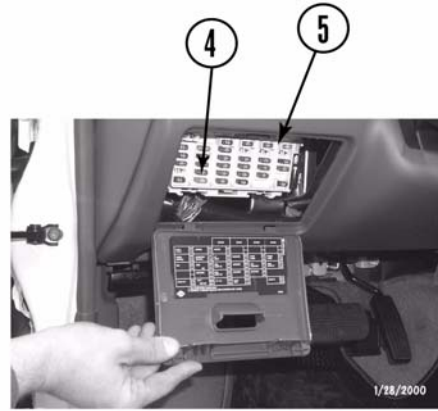

### **⚠WARNING**

Retorque all fasteners after 500 miles and after off road use. All body lift components should be visually inspected and fasteners retorqued during routine vehicle servicing.

- a. Check all mounting hardware to ensure it is properly tightened.
- b. Check all wires, hoses, cables, etc. to ensure they have been properly connected and there is ample slack. With the number of hoses on this vehicle, it is vital that this be checked thoroughly.
- c. Check vehicle electrical system.
- d. Start vehicle and check the steering in both directions to ensure that there is no bind. Check clutch operation. Check the operation of the brake system and the parking brake. Check both shift levers' operation. Ensure that there is proper engagement in all gears and 4 wheel drive ranges.
- e. Check coolant level. Fill coolant to the proper level (refer to the Owner's Manual).

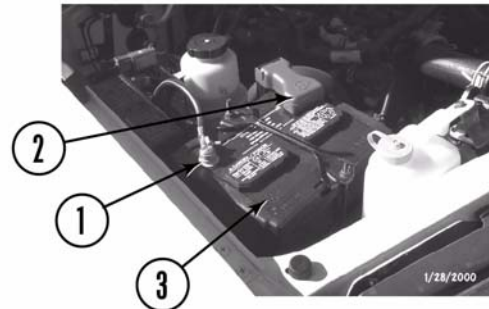

### **⚠WARNING**

If the engine cooling system is hot, the coolant will be HOT and UNDER PRESSURE. To prevent serious personal injury, wait until the cooling system is completely cool before removing the cap from the radiator.

- f. Test drive vehicle in all gears and 4 wheel drive ranges. Pay close attention to all vehicle systems. Check all hardware again in 500 miles and as part of your regular maintenance schedule.

### **⚠CAUTION**

Performance Automotive Group does not recommend any particular wheel and tire combinations for use with its body lifts and cannot assume responsibility for the customer's choice of wheels and tires. Refer to your owner's manual for recommended tire sizes and warnings related to the use of oversized tires. Larger wheel and tire combinations increase stress and wear on steering and suspension components, which leads to increased maintenance and higher risk for component failure. Larger wheel and tire combinations also alter speedometer calibration, braking effectiveness, center of gravity, and handling characteristics. Consult an experienced local off road shop to find what wheel and tire combinations work best with your vehicle.

### **NOTE**

All warranty information, instruction sheets, and other documents regarding the installation of this product must be retained by the vehicle owner. Information contained in the instructions and on the warranty card will be required for any warranty claims. The vehicle owner needs to understand the modifications made to the vehicle and how they affect vehicle handling and performance. Failure to provide the customer with this information can result in damage to the vehicle and severe personal injury.

## **Accessories**

### **Kit# 6415 (2WD), 6416 (4WD) Gap Guards**

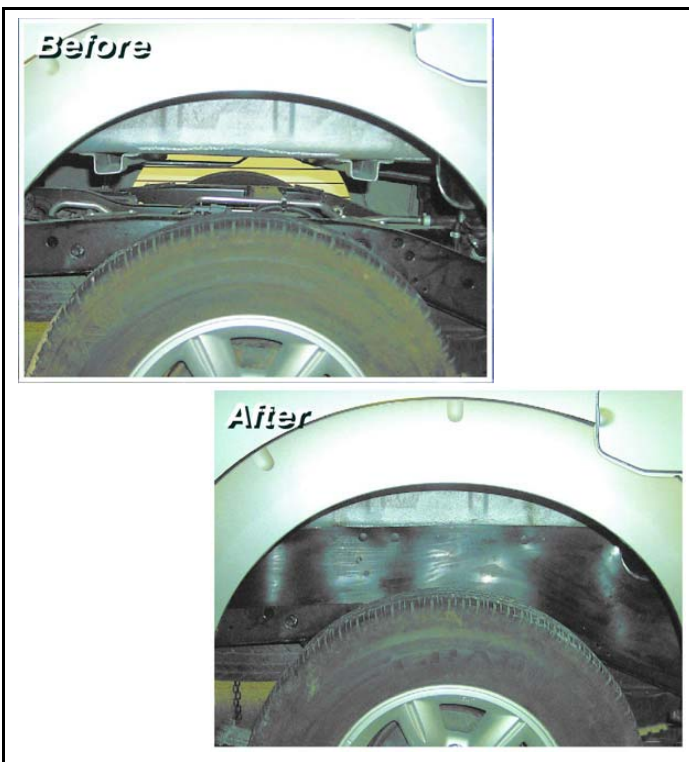

## E. Kit Parts List.

Quantity	Description
1	Transmission shifter extension
2	Front bumper brackets
2	Rear bumper brackets
1	Lower radiator support bracket
2	Outside cab support brackets
1	Power steering reservoir bracket
1	1 3/4" x 3" fuel-filler extension
1	1/2" x 19" fuel vent hose
1	1/4" x 17" fuel vent hose
1	Warning to driver sticker
1	Logo label
8	3 x 3 blocks
6	3 x 2 blocks
2	2 x 3 spacers with holes
4	2 x 3 spacers without holes
1	10ml bottle Loctite® 262

Quantity	Description
1	<b>Bolt pack BP4003</b>
6	7/16" x 7" bolts
2	10mm x 190mm bolts
2	12mm x 210mm bolts
2	7/16" x 1 1/2" bolts
2	1/2" x 5" bolts
2	1/2" x 5 1/2" bolts
6	Thick 1/2" USS washers
6	1/2" USS washers
6	3/8" SAE washers
4	7/16" nylock nuts
6	1/2" nuts
1	se 9000 steering extension
1	3/8" x 1 1/4" socket head bolt

Quantity	Description
1	<b>Hardware Pack HP4003</b>
	<i>Bolts</i>
16	7/16" x 1" bolts
2	10mm x 100mm bolts
2	3/8" x 1" bolts
2	5/16" x 1" bolts
2	1/4" x 1" bolts
	<i>Washers</i>
8	7/16" SAE washers
24	7/16" USS washers
4	3/8" SAE washers
4	5/16" USS washers
4	1/4" SAE washers
	<i>Nuts</i>
16	7/16" nylock nuts
2	3/8" nylock nuts
2	5/16" nylock nuts
2	1/4" nylock nuts

## Miscellaneous

4	#6 hose clamps
2	#10 hose clamps
2	#28 hose clamps
2	3/8" x 3" scd. 40 cab safety strap
1	3/8" x 4" scd. 40 heater hose ext.
1	7/16" x 3" .049" vacuum hose ext.
2	1/8" x 1" roll pins

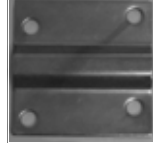

Front bumper bracket

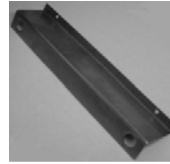

Lower radiator bracket

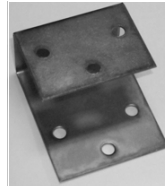

Power steering reservoir bracket

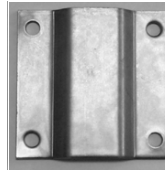

Outer cab support straps



2 x 3 spacers with holes