



3651 N Highway 89 • Chino Valley, AZ 86323
(928) 636-7080 • www.p-a-g.net

CHEVY/GMC TAHOE, YUKON, SUBURBAN, XL, DENALI 3" BODY LIFT KIT INSTALLATION INSTRUCTIONS 2007 KIT# 10183

⚠ WARNING

Installation of a Performance Automotive Group body lift kit will change the vehicle's center of gravity and handling characteristics both on- and off-road. You must drive the vehicle safely! Extreme care must be taken to prevent vehicle rollover or loss of control, which could result in serious injury or death. Avoid sudden sharp turns or abrupt maneuvers and always make sure all vehicle occupants have their seat belts fastened.

⚠ WARNING

Before you install this kit, read and understand all instructions, warnings, cautions, and notes in this instruction sheet and in the vehicle owner's manual.

⚠ CAUTION

Proper installation of this kit requires knowledge of the factory recommended procedures for removal and installation of original equipment components. We recommend that the factory shop manual and any special tools needed to service your vehicle be on hand during the installation. Installation of this kit without proper knowledge of the factory recommended procedures may affect the performance of these components and the safety of the vehicle. We strongly recommend that a certified mechanic familiar with the installation of similar components install this kit.

⚠ WARNING

DO NOT combine suspension, body, or other lift devices. Use of vehicle with combined lifts may result in unsafe and/or unexpected handling characteristics.

⚠ WARNING

This kit should only be installed on a vehicle that is in good working condition. Before you install the kit, thoroughly inspect the vehicle for corrosion or deformation of the sheet metal around the factory body mounts. If the vehicle is suspected to have been in a collision or misused, do not install this kit. Off-road use of your vehicle with this kit installed may increase the stress applied to the factory body mounts. We do not recommend that any vehicle with a body lift kit installed be involved in any extreme off-road maneuvers such as jumping. Failure to observe this warning may result in serious personal injury and/or severe damage to your vehicle.

⚠ WARNING

Many states and municipalities have laws restricting bumper heights and vehicle lifts. Consult state and local laws to determine if the changes you intend to make to the vehicle comply with the law.

⚠ WARNING

The installation of larger tires may reduce the effectiveness of the braking system.

⚠ WARNING

Always wear eye protection when operating power tools.

⚠ WARNING

Before you install this kit, block the vehicle tires to prevent the vehicle from rolling.

⚠ WARNING

Accidental deployment of the air bag can result in serious personal injury or death. To avoid accidental deployment during installation of the kit, the Supplemental Restraint System (SRS, or airbag) must remain deactivated. Do not allow anyone near the airbag during installation. Refer to the factory service manual or owner's manual for the recommended procedure to disable the SRS. After you install the kit, reactivate the SRS before driving the vehicle.

NOTE

Performance Automotive Group recommends using the Loctite® supplied in the kit on the threads of all kit nuts and bolts unless specified otherwise in these instructions.

Before Starting Installation

NOTE
Kit parts are prefaced by the word *kit* and appear in **bold** print.

1. Carefully read all warnings and instructions completely before beginning.
2. Verify all parts have been received in this kit by checking the parts list at the end of this document.

NOTE
If parts are missing from kit, please be prepared to provide the following information:
1. **Name** of purchase location
2. **Bar Code** on side of box
3. **Date** above bar code
4. **Date** inside box cover
5. **Inspector #** from inside box cover

3. **Only install this kit on the vehicle for which it is specified.** If anytime during the installation you encounter something different from what is outlined in the instructions, call technical support at (928) 636-7080.
4. Special tools needed:
 - a. Die grinder or plasma torch capable of cutting metal.
 - b. 3/8", 7/16" and 9/16" drill bit
 - c. Center punch set
 - d. Telescoping magnet
5. Park vehicle on a clean, dry, flat, level surface and block tires so vehicle cannot roll in either direction.

Engine Compartment

1. Disconnect both battery cables. Disconnect negative cable first, then positive cable.
2. Airbag Fuse

NOTE
The location of the airbag fuse may vary; check the owner's manual.

- a. Remove fuse cover.
- b. Remove airbag fuse.

Prepare to Install Kit

Front of Vehicle

1. Grille & Fascia
 - a. Disconnect two fog lamp connectors from fog lamps, if equipped.

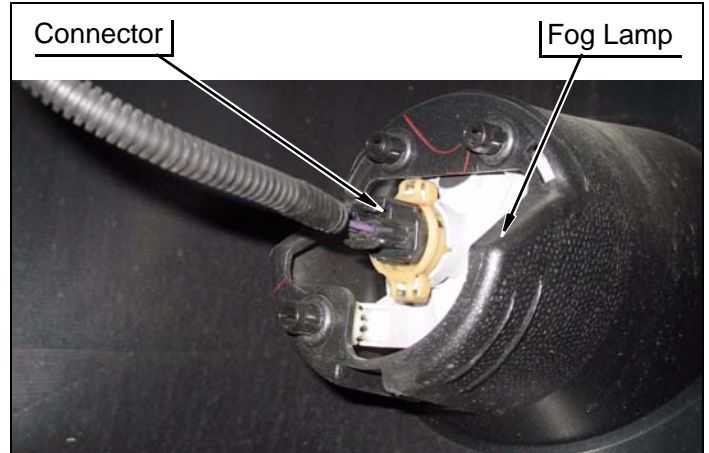

- b. Remove six bolts and grille from core support.

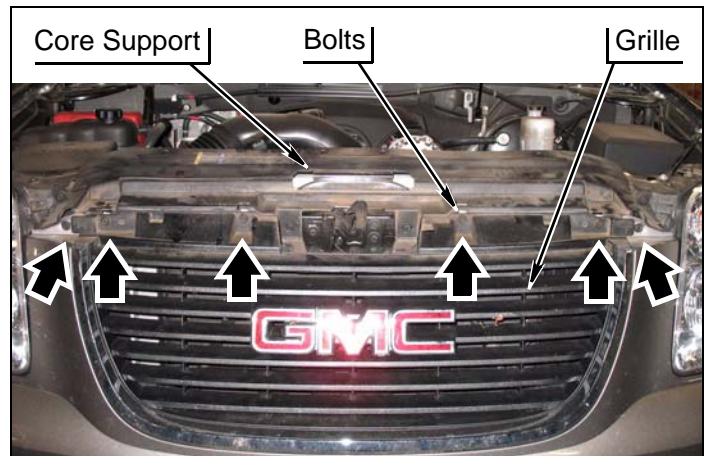

- c. Remove two bolts and fascia support from bumper.

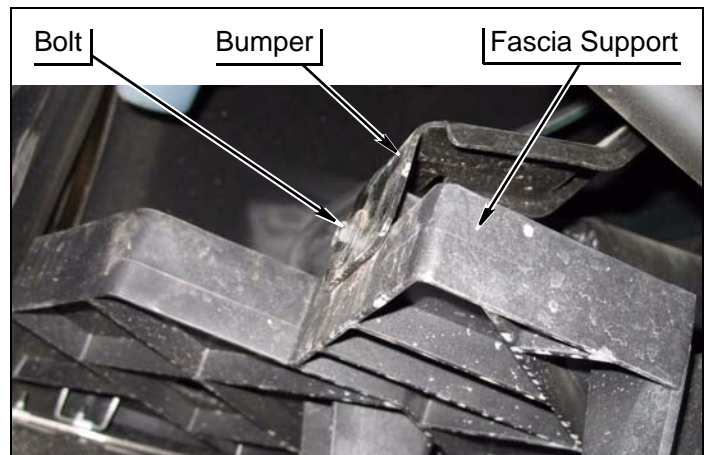

d. Remove four bolts, four push clips and fascia from two wheel wells.

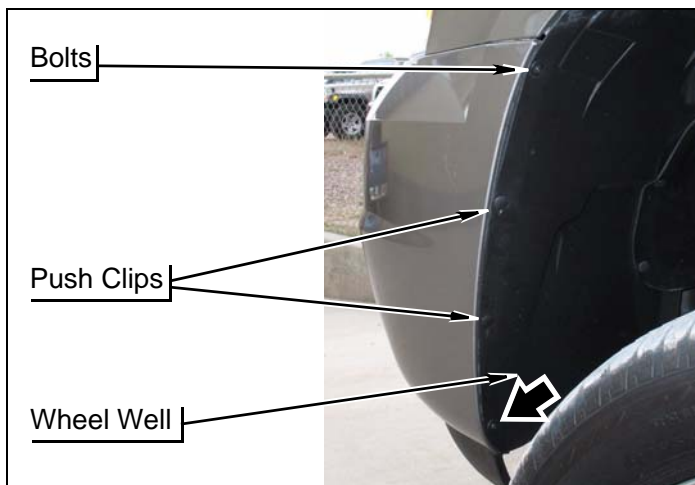

e. Carefully remove left and right fascia from clips on two fenders and vehicle.

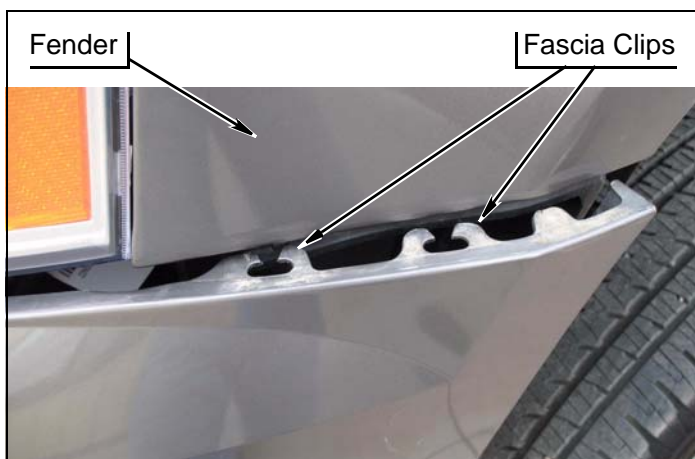

2. Front Bumper

a. Remove two clips and wiring harnesses from bumper.

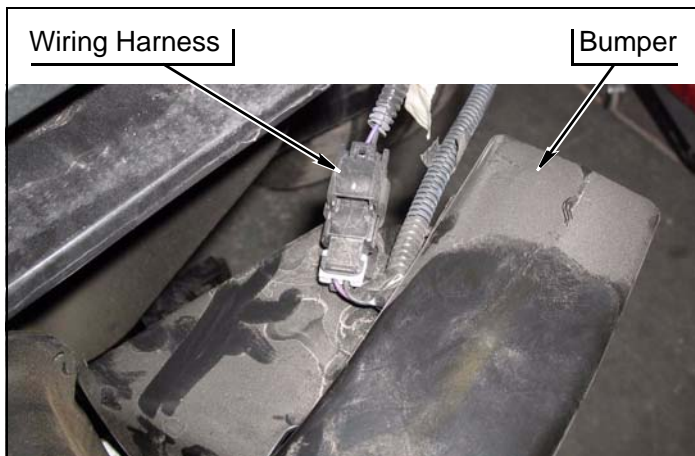

b. Remove two bolts and bumper from frame horns.

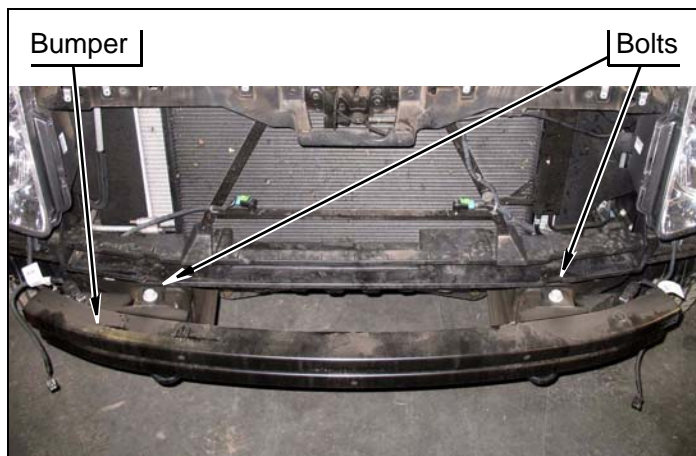

c. Remove four bolts, two nuts and two tow hooks from frame horns.

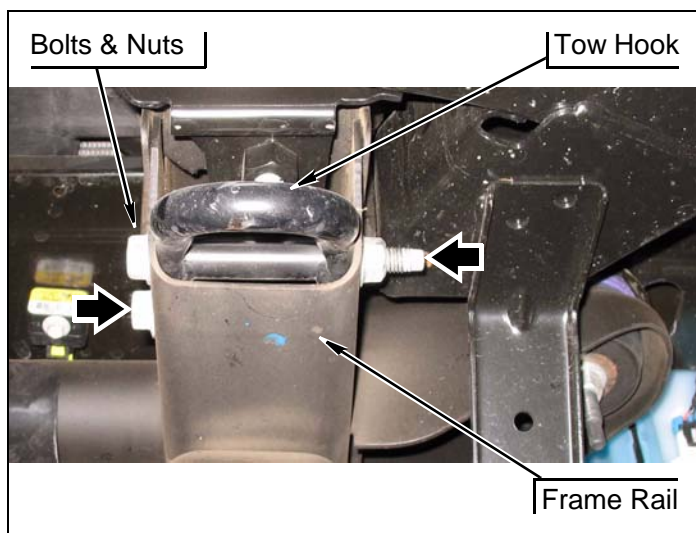

Engine Compartment

1. Airbox

a. Pull up and remove cover from engine.



b. Loosen two clamps on airbox and engine intake.

c. Remove clip and upper radiator hose from engine intake.

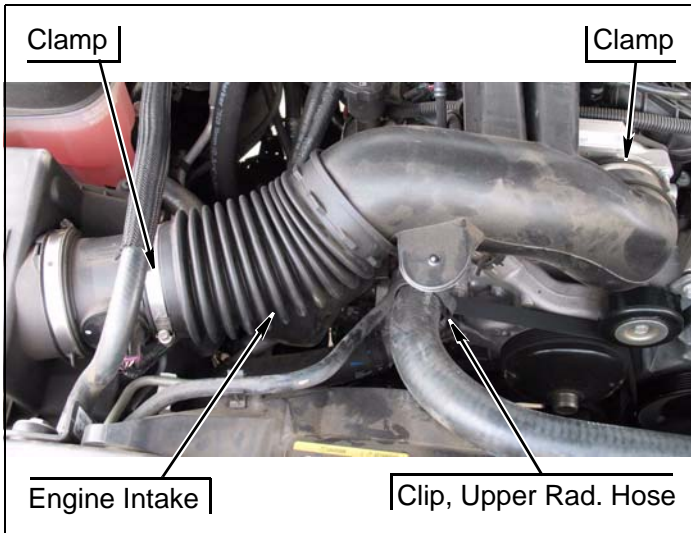

2. Remove nut and ground strap from left firewall.

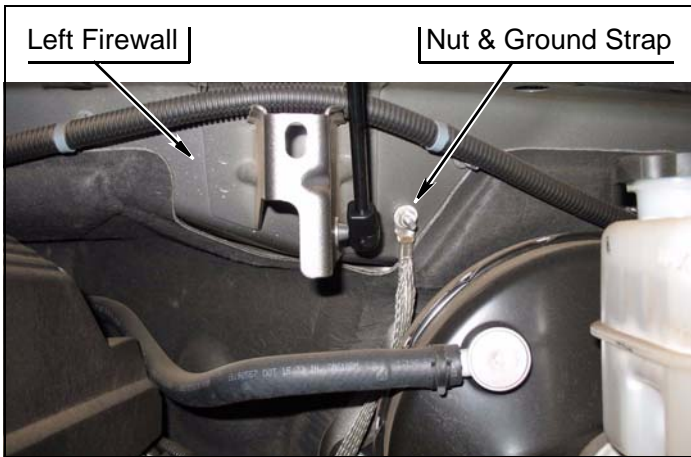

3. Remove brake lines from left frame rail and two clips.

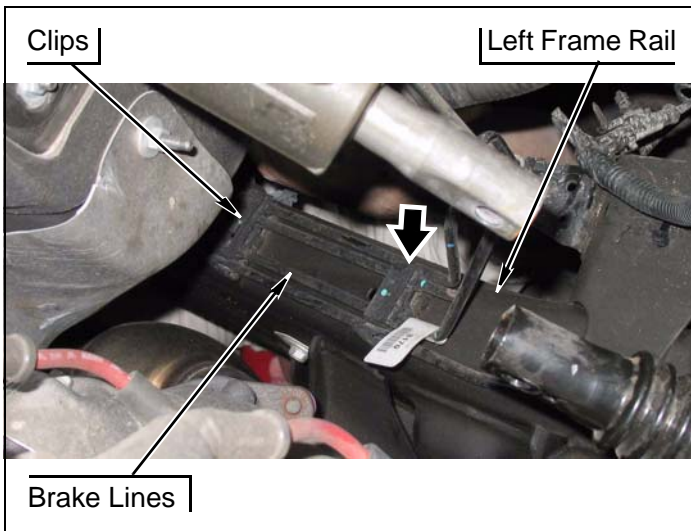

4. Remove left harness and clip from left firewall bracket, below brake master cylinder.

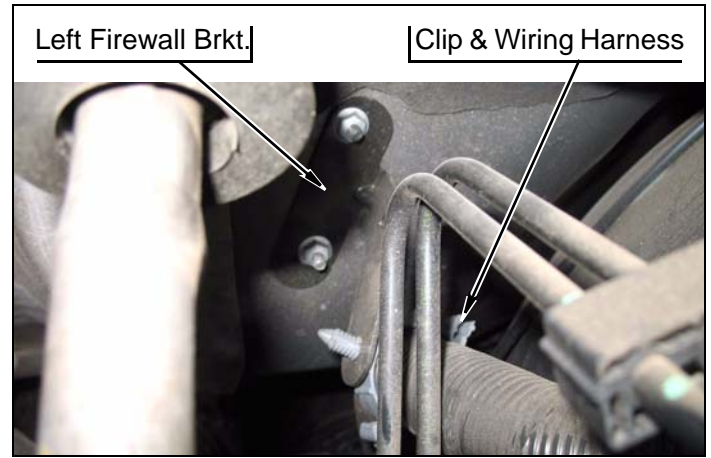

5. Remove harness from left wheel well, below fuse box.

6. Remove harness and clip from fuse box.

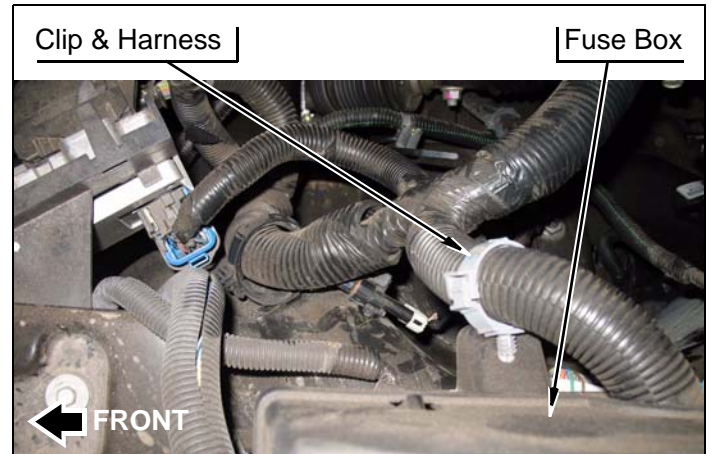

7. Steering Shaft

⚠ WARNING

Accidental deployment of the air bag can result in serious personal injury or death. To avoid accidental deployment during installation of the lift kit, the Supplemental Restraint System (SRS, or airbag) must remain deactivated. Do not allow anyone near the airbag during installation. Refer to the factory service manual or owner's manual for the recommended procedure to disable the SRS. After kit installation, the SRS must be reactivated before driving the vehicle.

⚠ CAUTION

If the following step is not performed, the airbag clockspring could be damaged. Do not turn the steering wheel while the steering shaft is disconnected.

- a. Strap steering wheel to prevent accidental movement.
- b. Mark upper steering shaft in relation to lower steering shaft as shown.

- c. Remove bolt, captive nut and lower steering shaft from upper steering shaft.

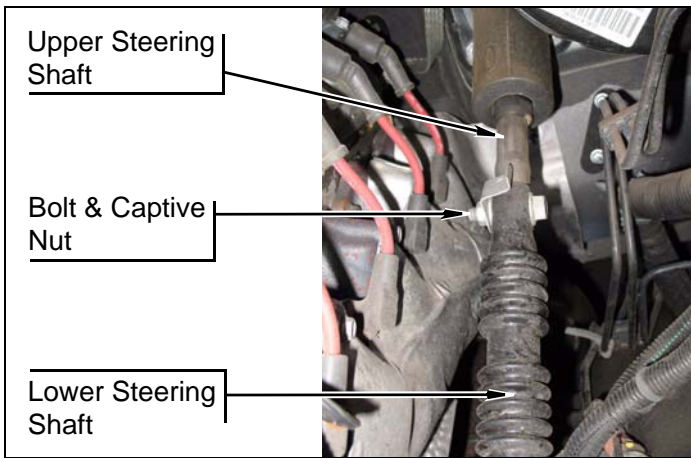

- 3. Remove clip and harness from left frame rail.

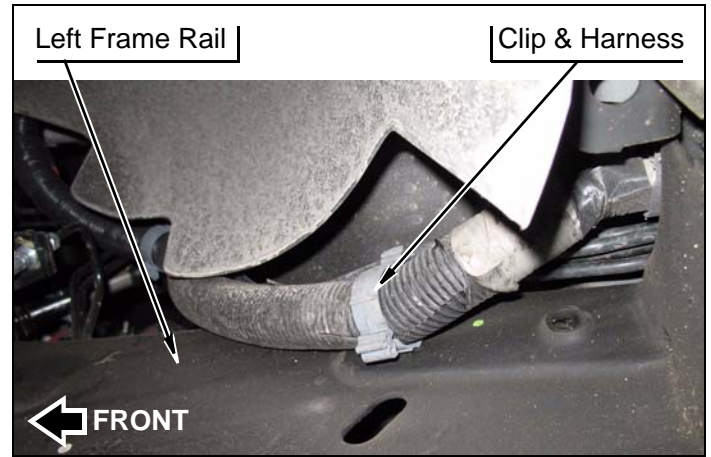

Underside of Vehicle

- 1. Remove bolt, metal clip and harness from right frame rail.

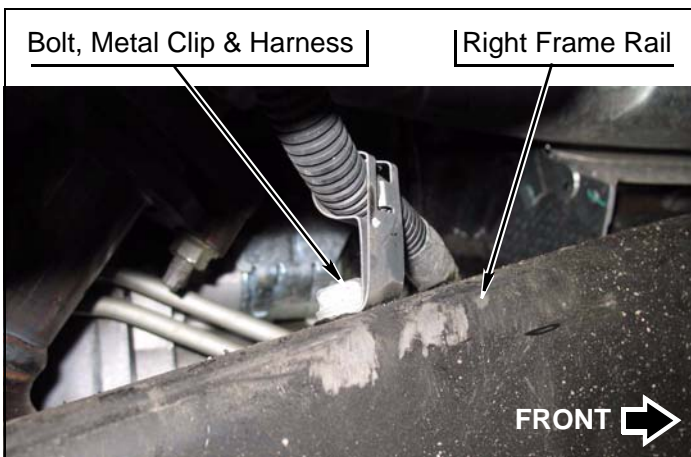

- 4. Parking brake cable

- a. Using locking pliers, pull slack into rear cable.
- b. Disconnect cable at junction near left frame rail.

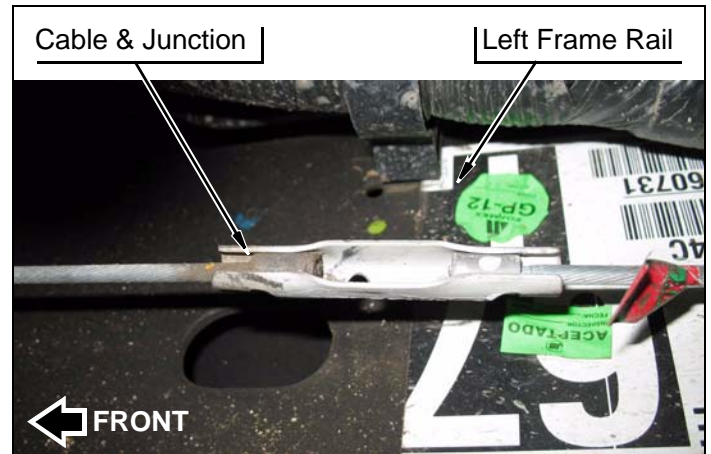

- 2. Remove two transmission cooler lines from metal clip and right side of engine block.

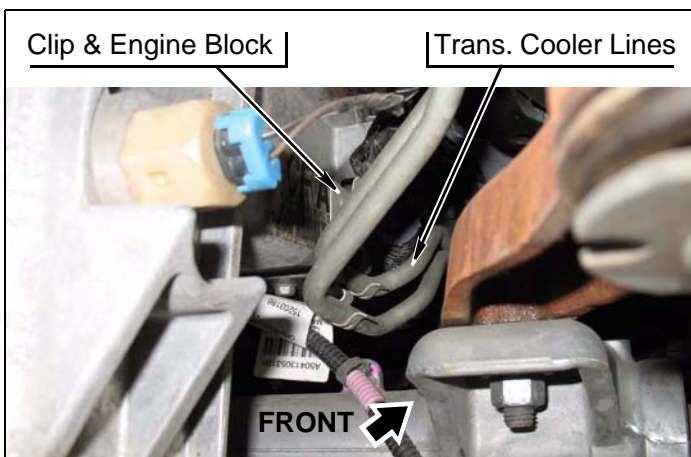

- c. Remove front cable from left frame body mount.

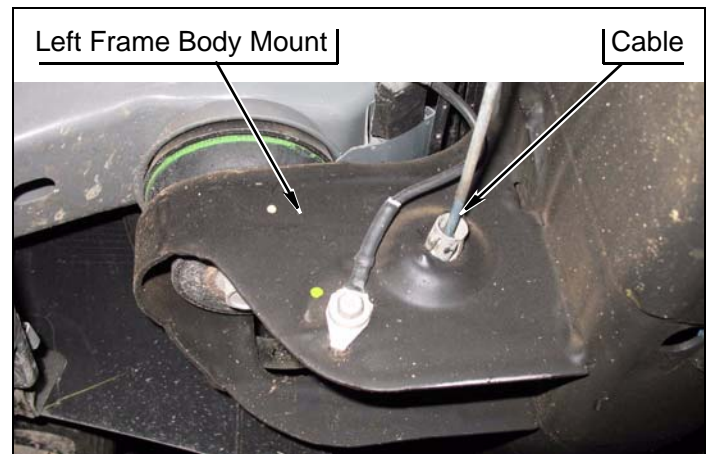

- Remove bolts and ground straps from front left, front right frame, left second and left rear body mounts.

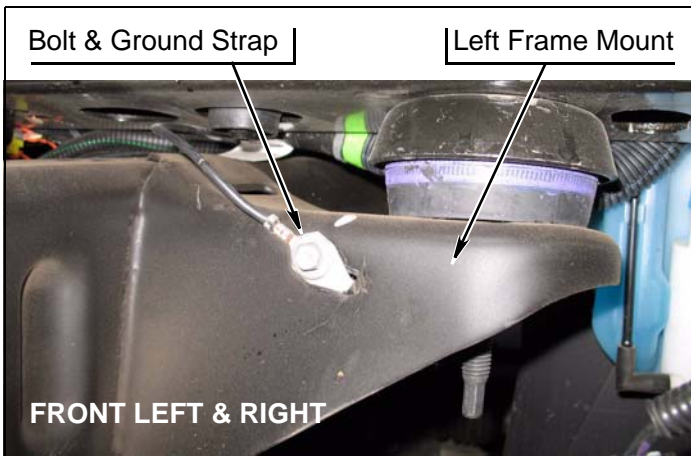

- Remove bolt, metal clip and harness from right front frame rail.

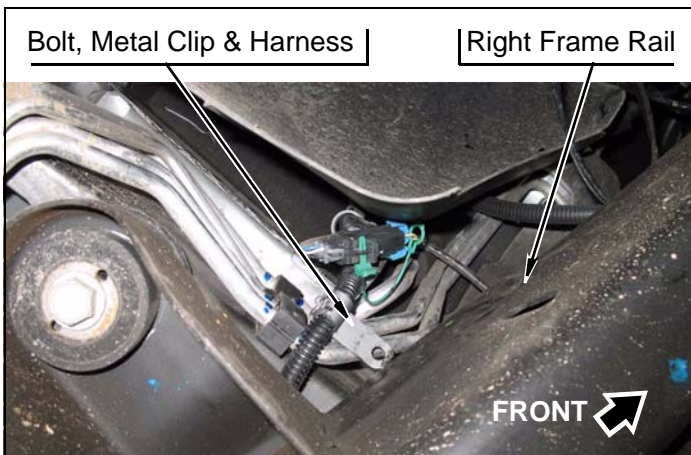

Rear of Vehicle

- Remove bolt and fuel filler from left rear frame rail.

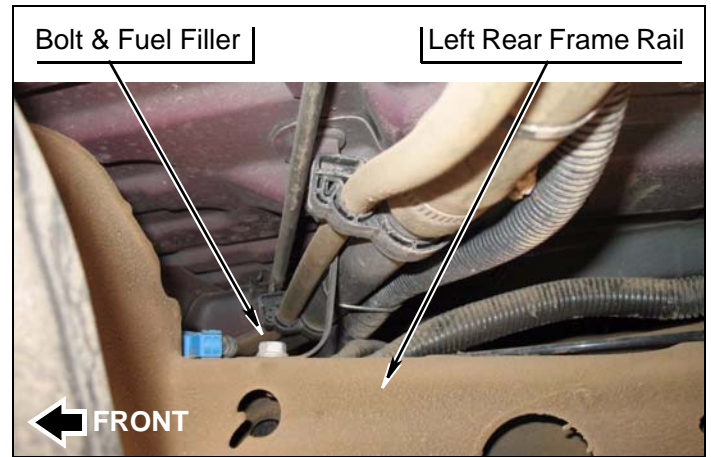

- Rear bumper
 - Remove four bolts, push clip and fascia from two wheel wells.

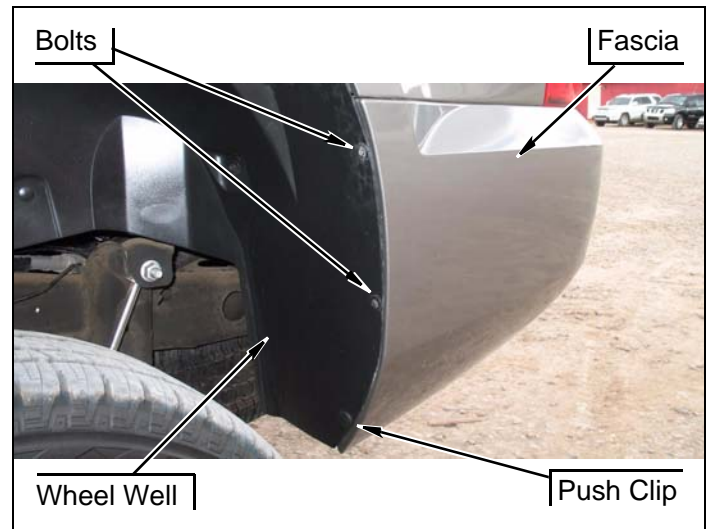

- Disconnect reverse sensor harness at junction on right rear fascia.

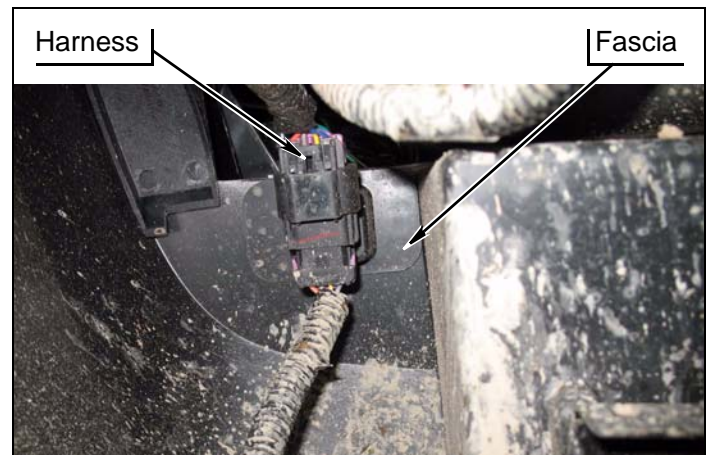

c. Open liftgate and remove four bolts and two push clips from body.

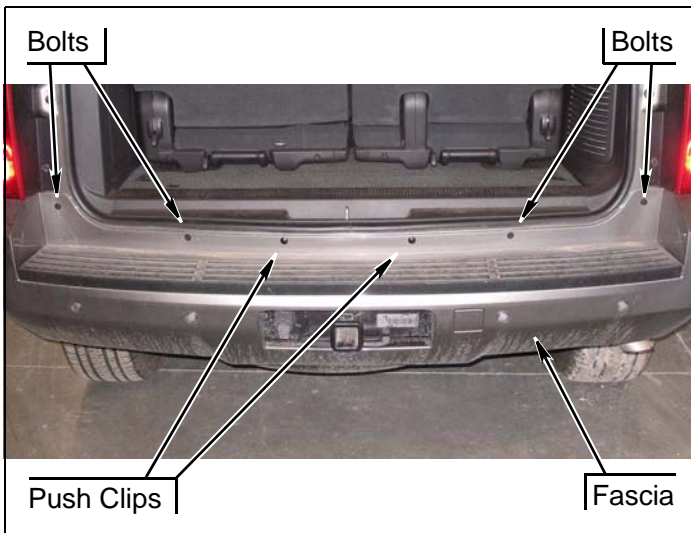

d. Remove left and right of fascia clips from body.

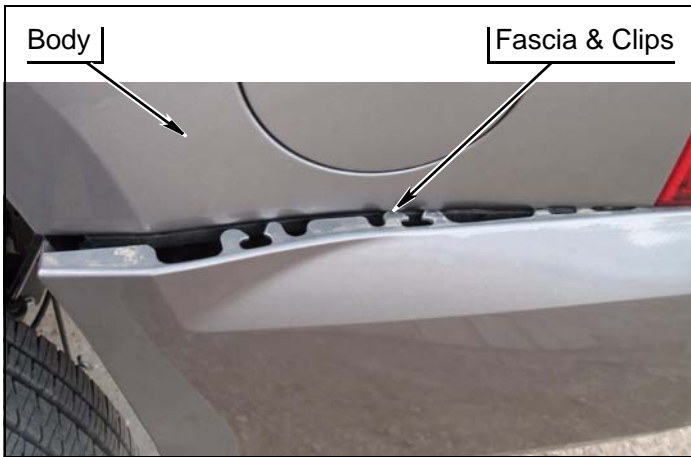

e. Remove two bolts and fascia from bumper and vehicles.

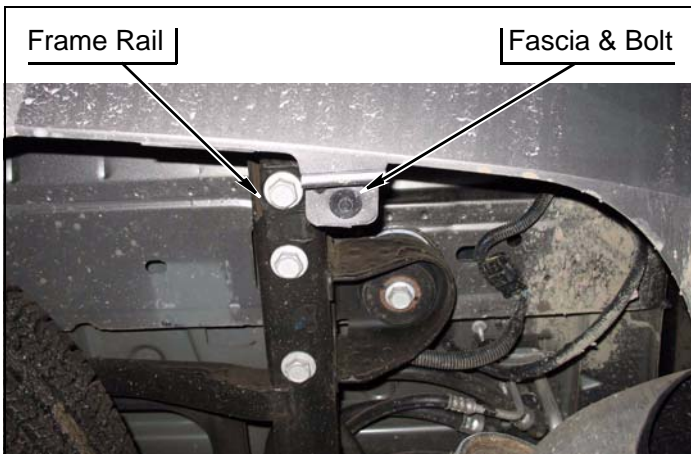

f. Remove spare tire according to vehicle owner's manual.

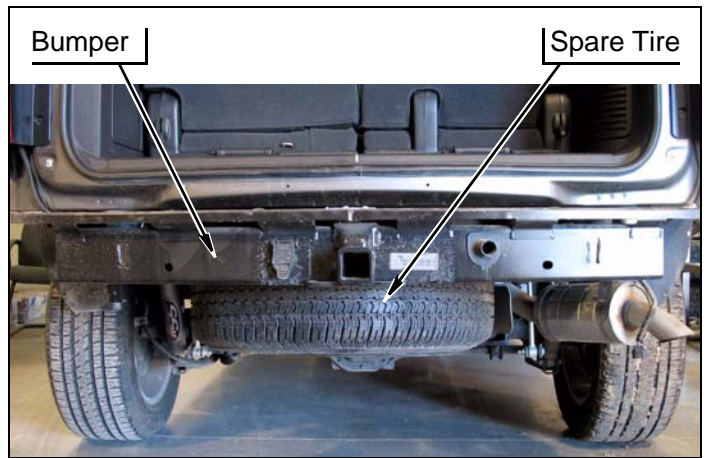

g. Remove trailer light harness from bumper.

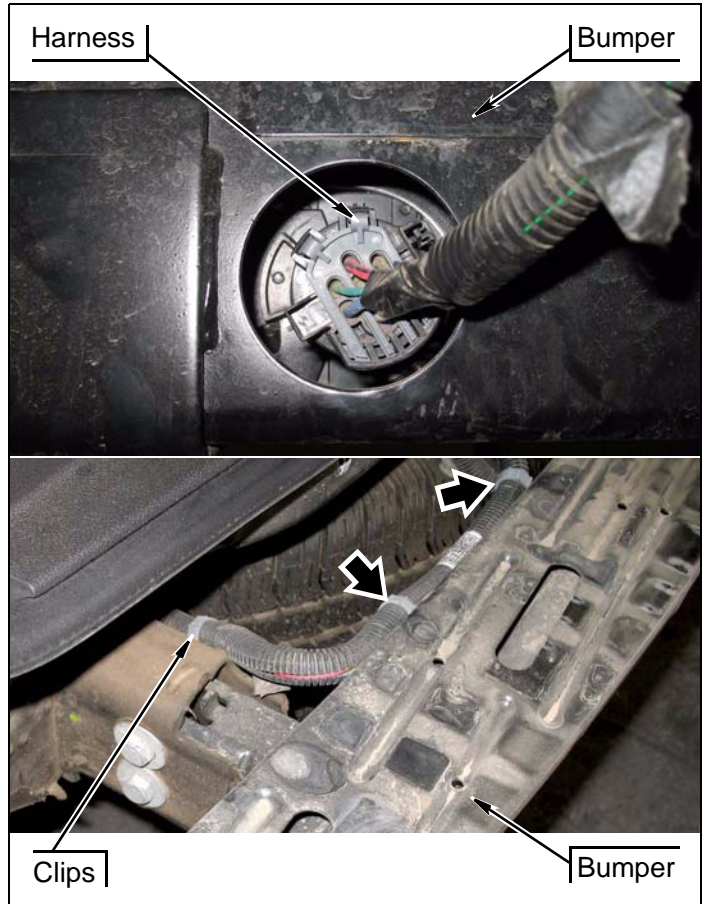

h. Remove ten bolts and bumper from frame rails.

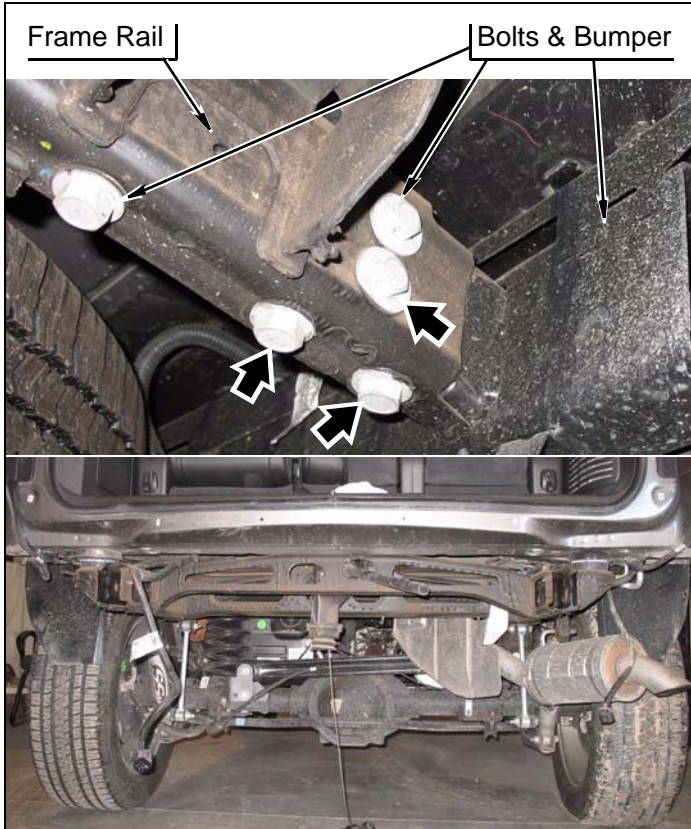

Install Kit

Cab

1. Prepare to lift cab from frame

a. Loosen, but DO NOT REMOVE, cab mounting bolts on left side.

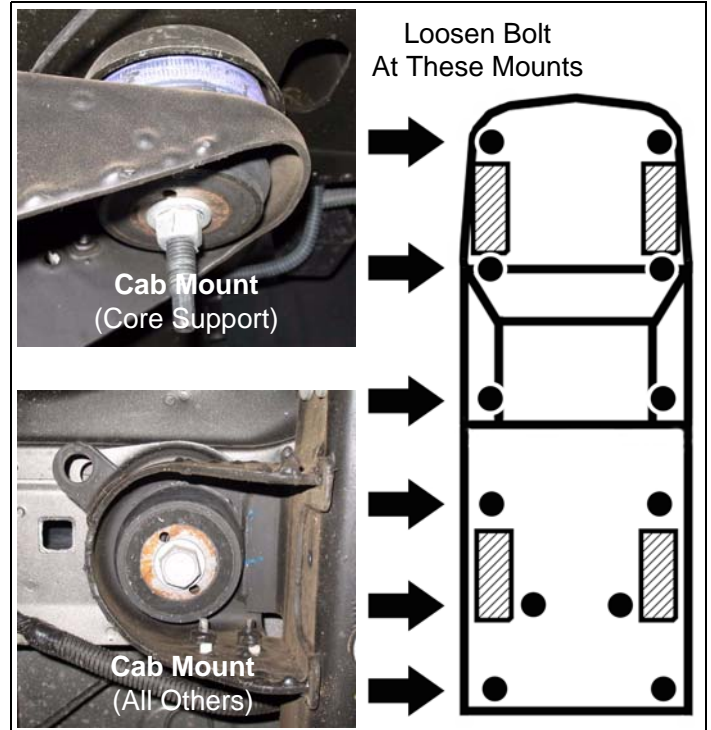

b. Remove bolt (and nut for core support) and lower bushing from each cab mount on right side.

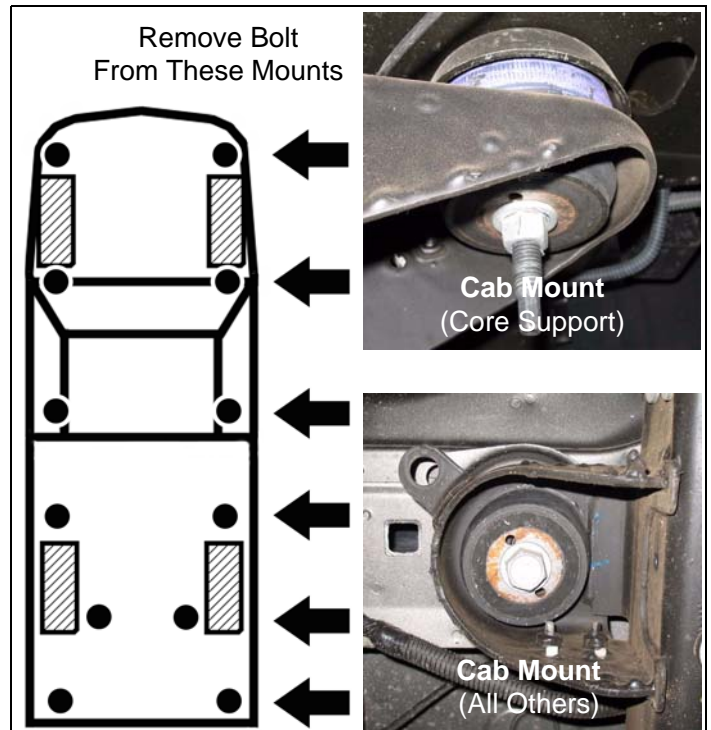

⚠ WARNING

Use extreme caution when lifting body from frame. To prevent serious personal injury, ensure the lifting device is securely placed. Keep your hands out from between the body and frame.

⚠ CAUTION

Continually check hoses, wires, lines, etc. to be sure that everything is flexing properly and not binding, or damage to the vehicle could result. Be especially careful of the a/c hoses at the fire wall, the belt pulley, and at the core support. Ensure brake lines stretch while lifting. Bending the lines to gain ample slack may be necessary. Be extremely careful not to kink the lines.

2. Right side of cab

- a. Position a hydraulic floor jack and wood block(s) under right side of cab (under the body seam). Slowly lift cab just enough to install a **kit block** on top of factory upper bushing.

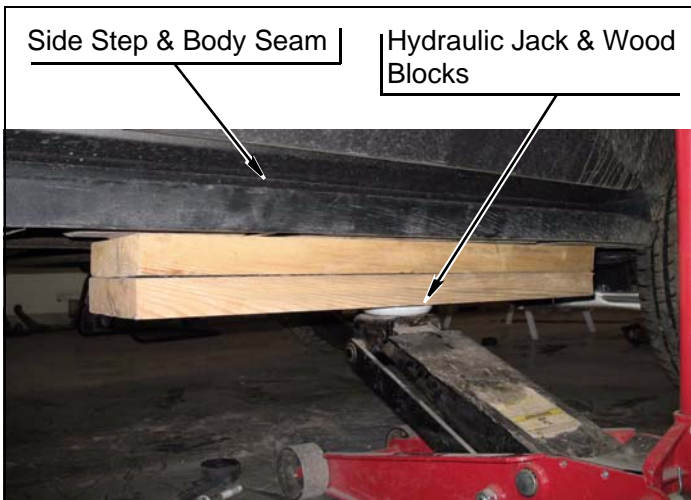

⚠ WARNING

The **kit blocks** must be installed in addition to the factory upper and lower bushings. Installing the **kit blocks** without the factory upper and lower bushings could result in damage to the vehicle or serious personal injury.

- b. Remove plastic sleeves from all upper bushings.

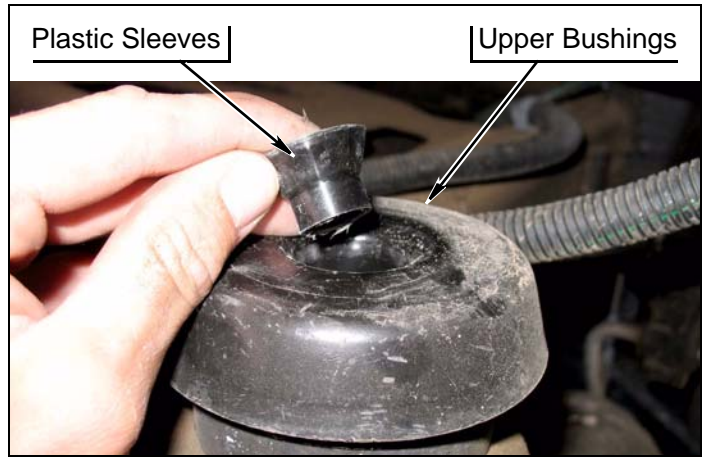

- c. Install **kit blocks** onto upper bushings on each cab mount.

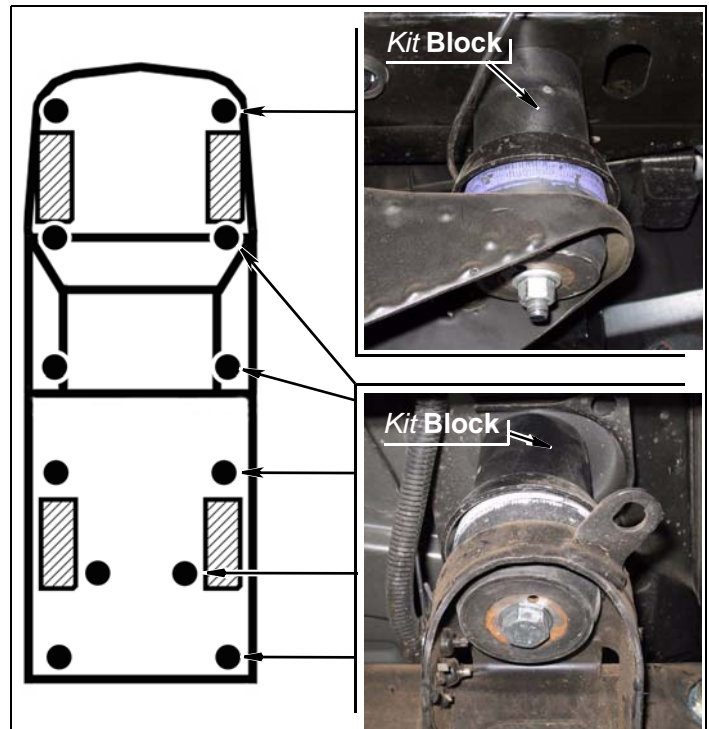

- d. Lower cab onto **kit blocks**.

- e. Install *kit bolt* (M12-1.75 x 180mm) and O.E. nut into core support cab mount and *kit block*. DO NOT TIGHTEN.

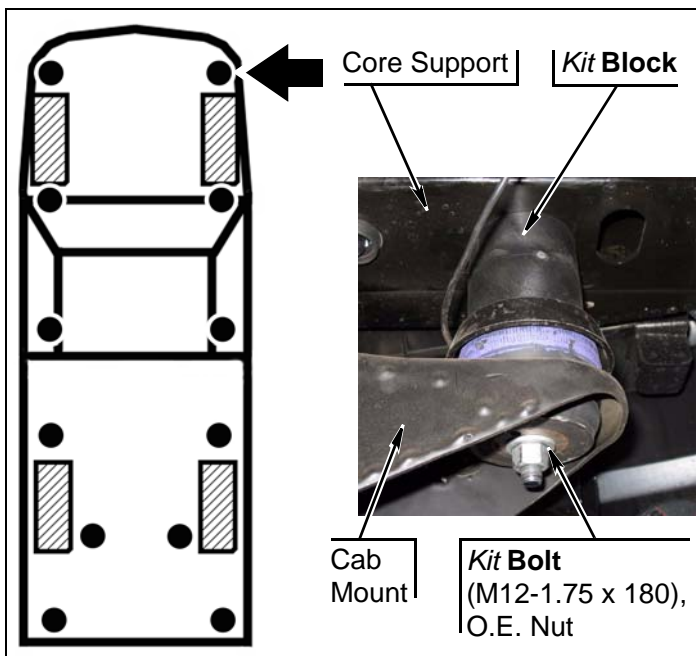

- h. Remove each *kit bolt*, one at a time, and apply a small amount of *kit Loctite*® onto threads. Install *kit bolt* and lower bushing (and O.E. nut for core support cab mount) into *kit block* and cab. TIGHTEN *kit bolts* to 55 ft. lbs.

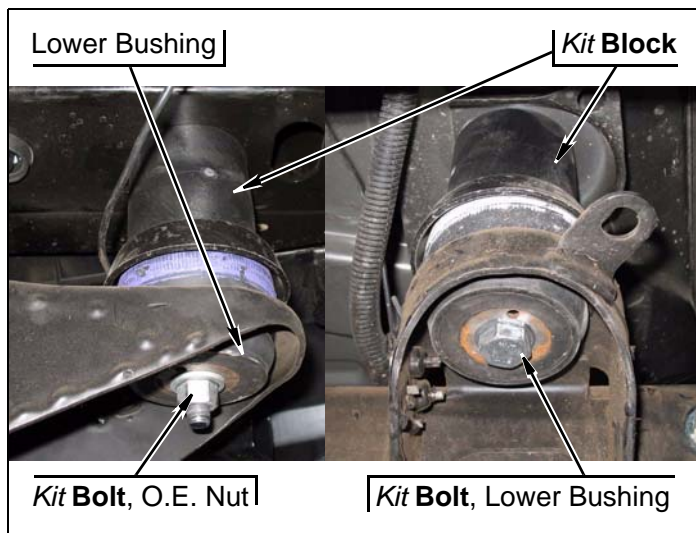

- f. Install *kit bolt* (M14-2.0 x 180mm) into remaining cab mounts and *kit blocks*. DO NOT TIGHTEN.

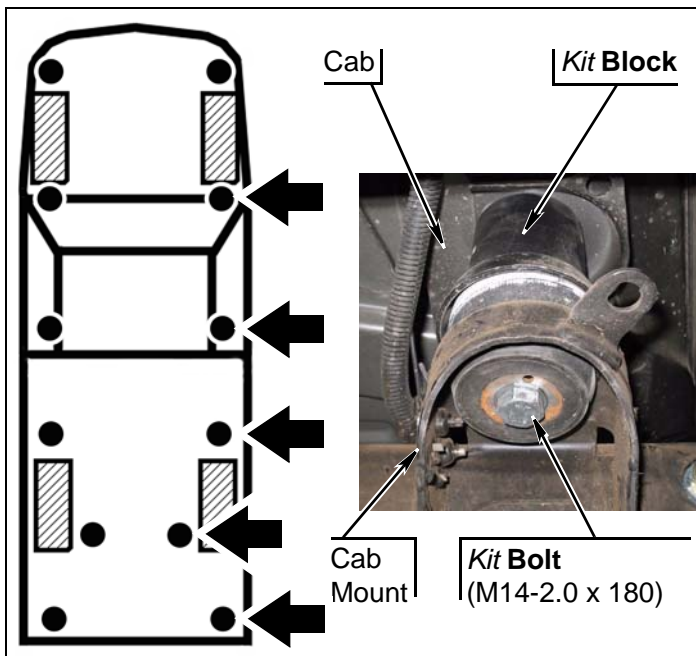

- g. Repeat previous substeps for left side of cab.

Rear of Vehicle

1. Rear bumper

- a. Cut along welds of two brackets and remove from bumper.



- b. Install two *kit brackets* (bumper, rear) onto bumper.

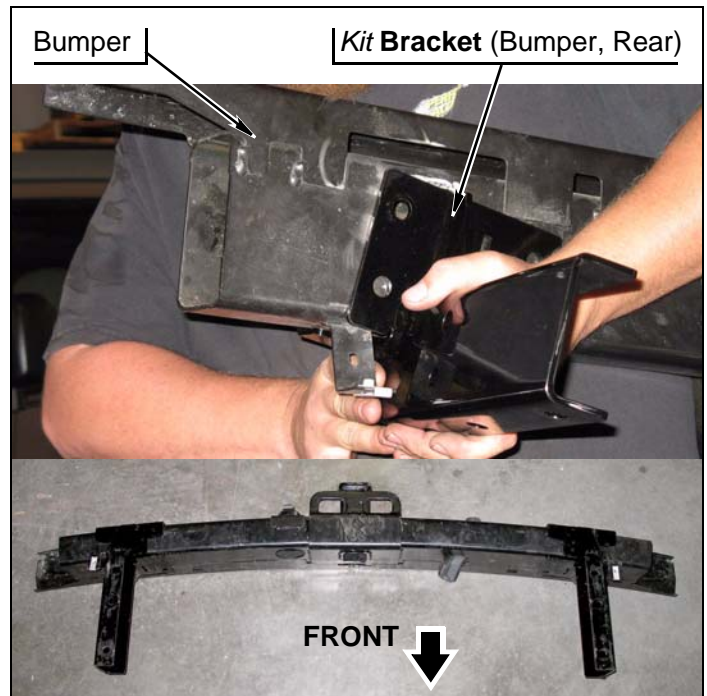

- c. Install bumper onto frame rails with four *kit bolts* (1/2"-13 x 1-1/2"), eight *kit washers* (1/2" SAE) and four *kit nuts* (1/2"-13 Stover). Snug, but DO NOT TIGHTEN.

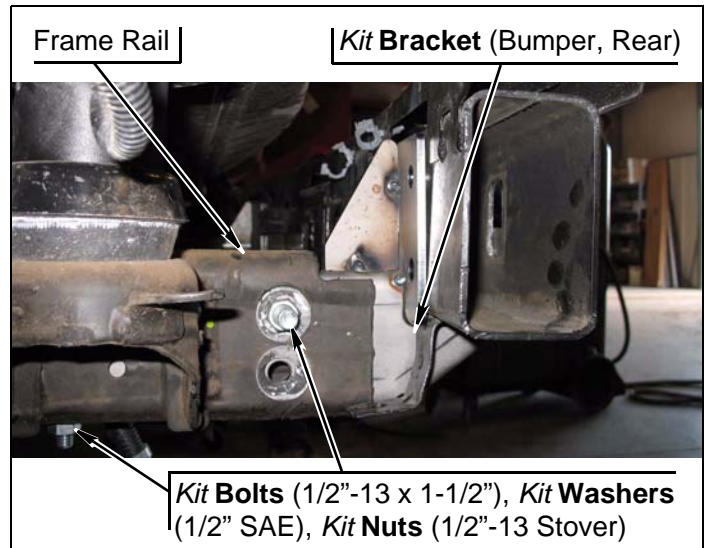

- d. Mark six drill holes through **kit brackets** (bumper, rear) onto bumper with center punch.

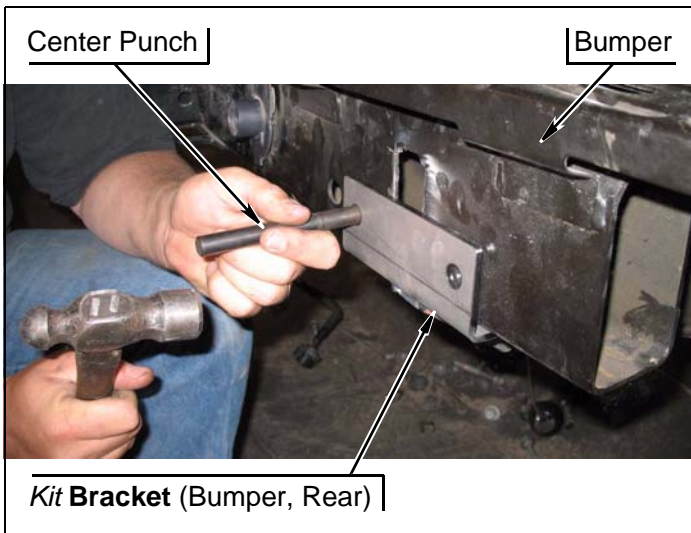

- e. Remove **kit bolts**, **kit washers**, **kit nuts**, **kit brackets** (bumper, rear) and bumper from frame rails.
- f. Drill six 9/16" holes through bumper at marked locations.

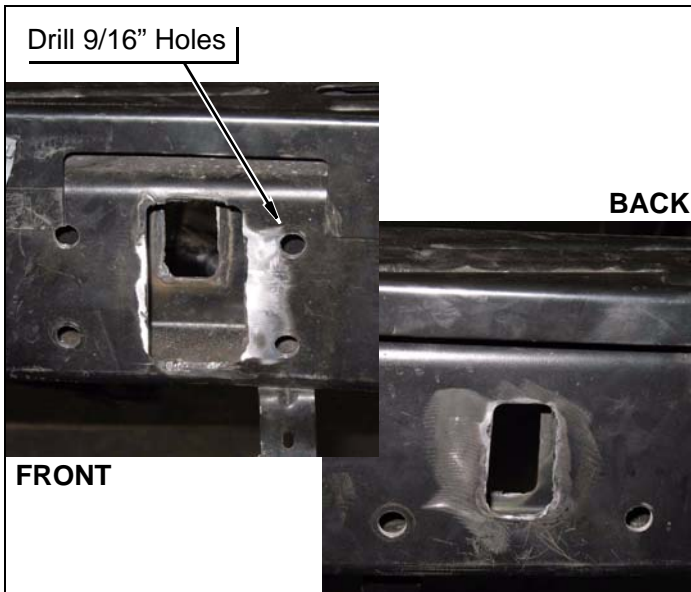

- g. Install **kit bracket** (bumper, rear, left) onto bumper with two **kit sleeves** (.75" OD x .532" ID x 2.43" L), two **kit bolts** (1/2"-13 x 4-1/2") and two **kit washers** (1/2" SAE).

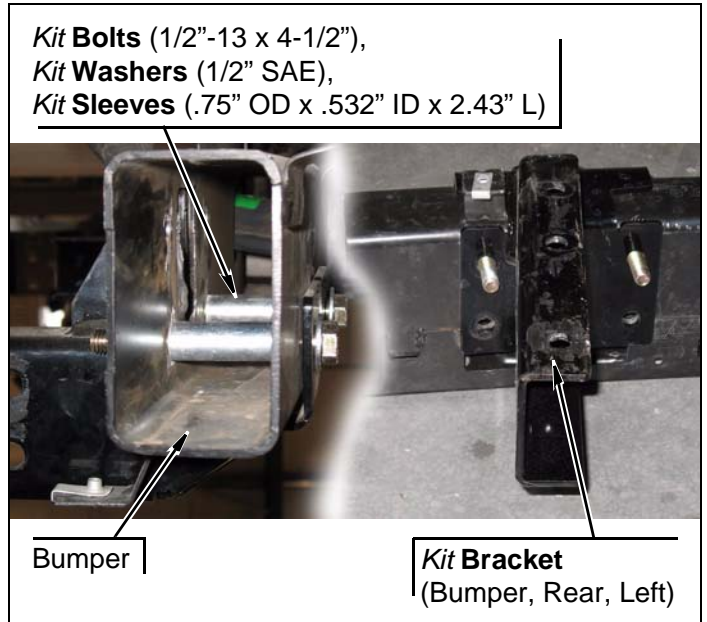

- h. Install **kit bracket** (bumper, rear, left) onto bumper with **kit bolt** (1/2"-13 x 1-1/2"), two **kit washers** (1/2" SAE) and **kit nut** (1/2"-13 Stover). DO NOT TIGHTEN.

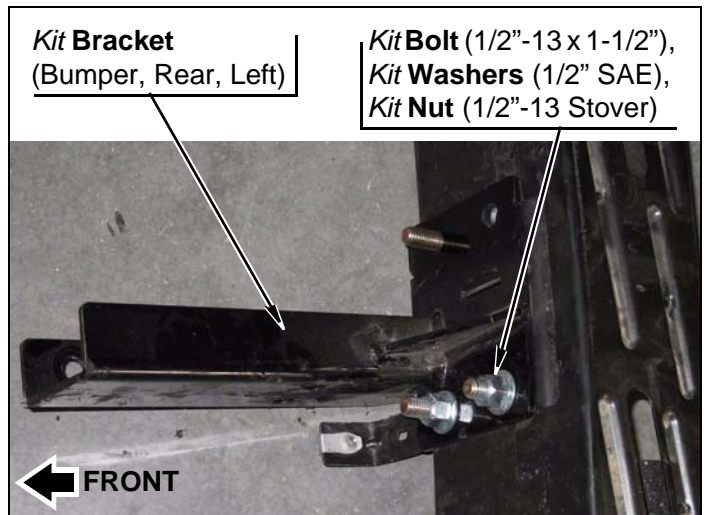

- i. Repeat above two substeps for **kit bracket** (bumper, rear, right).

- j. Install bumper and two **kit brackets** (bumper, rear) onto frame rails. Align forward most holes.

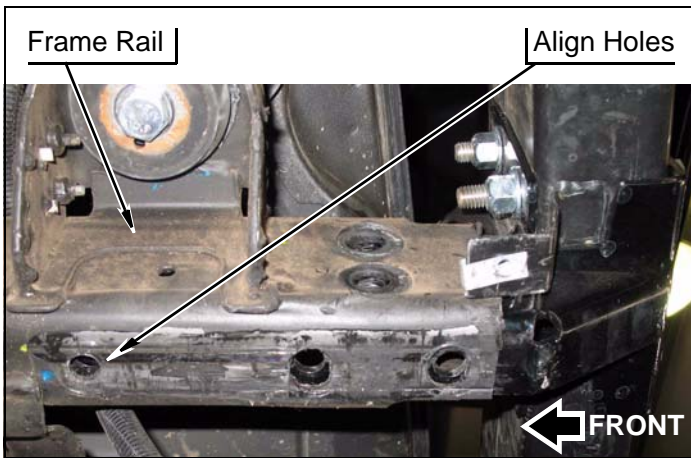

- k. Install two **kit brackets** (bumper, rear, support) onto **kit brackets** (bumper, rear) with two **kit bolts** (1/2"-13 x 1-1/2"), six **kit washers** (1/2" SAE) and four **kit nuts** (1/2"-13 Stover). Snug, but DO NOT TIGHTEN.

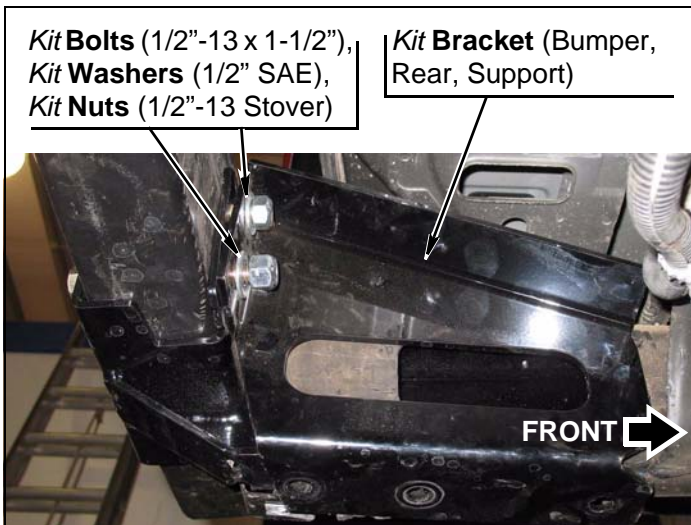

- l. Install bumper, two **kit brackets** (bumper, rear, support) and two **kit brackets** (bumper, rear) onto frame rails with two **kit bolts** (1/2"-13 x 1-1/2"), four **kit washers** (1/2" SAE) and two **kit nuts** (1/2"-13 Stover). TORQUE to specification. Install spare tire winch tube into bumper.

- m. Install bumper, two **kit brackets** (bumper, rear, support) and two **kit brackets** (bumper, rear) onto frame rails with four **kit bolts** (1/2"-13 x 1-1/2"), eight **kit washers** (1/2" SAE) and four **kit nuts** (1/2"-13 Stover). TORQUE to specification.

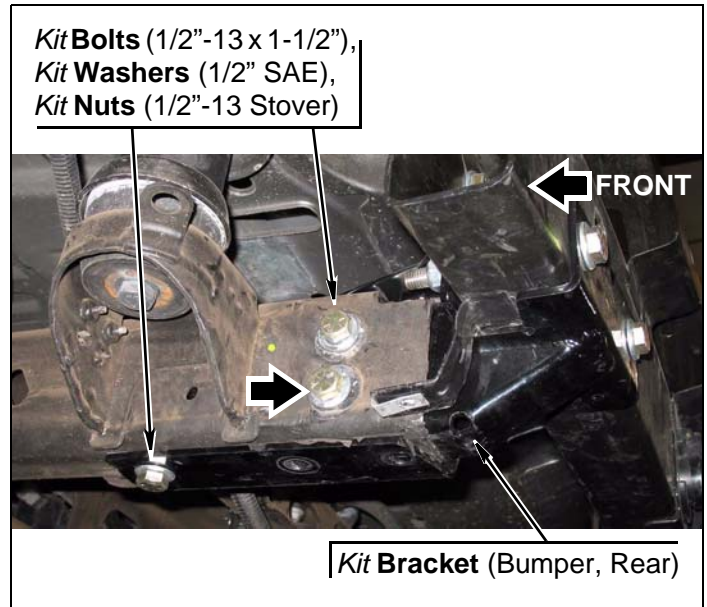

- n. Install bumper, two **kit brackets** (bumper, rear, support) and two **kit brackets** (bumper, rear) onto frame rails with four **kit bolts** (1/2"-13 x 1-1/2"), eight **kit washers** (1/2" SAE) and four **kit nuts** (1/2"-13 Stover). TORQUE to specification.

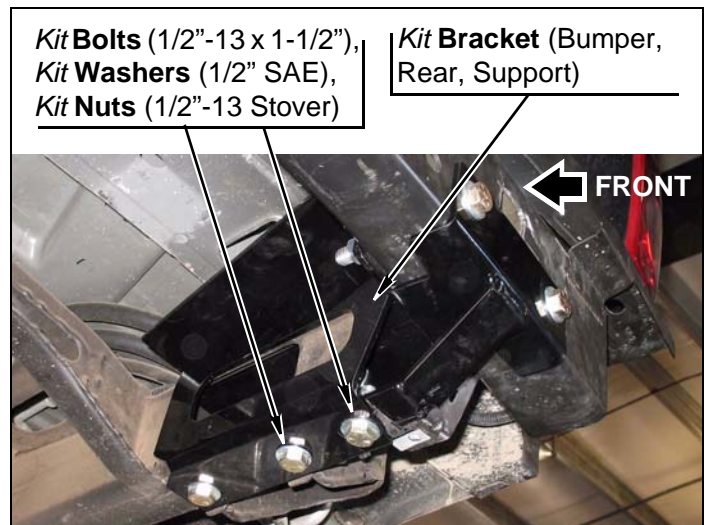

- o. TORQUE all bumper hardware to specification.
- p. Install fascia onto cab with four bolts and two push clips.
- q. Install left and right clips of fascia into vehicle.

- r. Mark and trim two lower fascia tabs. Install onto bumper with two bolts.

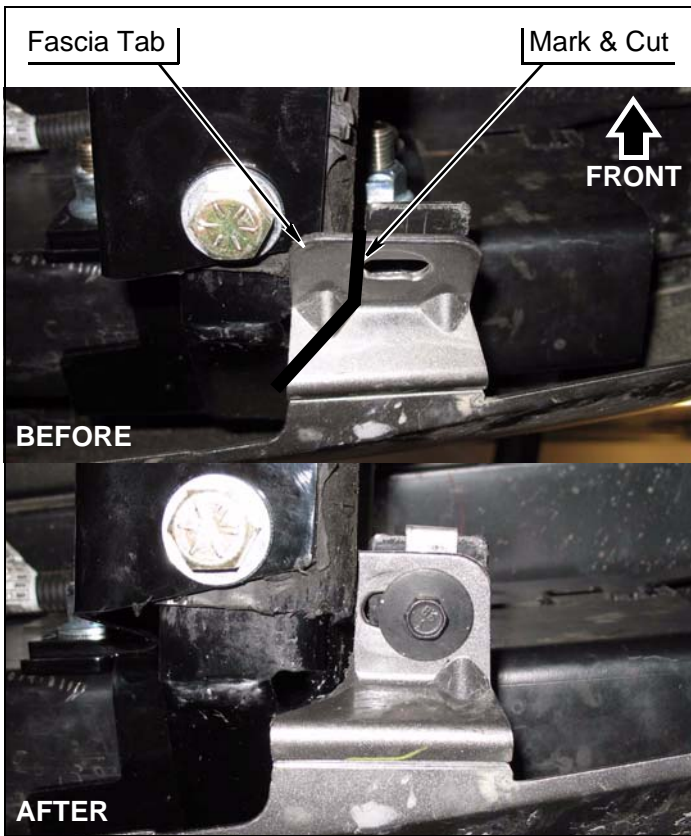

- s. Connect reverse sensor harness.
- t. Connect trailer light harness onto bumper.
- u. Install spare tire onto vehicle according to vehicle owner's manual.

- 2. Install fuel filler onto left frame rail with *kit bolt* (M8-1.25 x 70), two *kit washers* (5/16" SAE) and *kit sleeve* (.50" OD x .382" ID x 2" L).

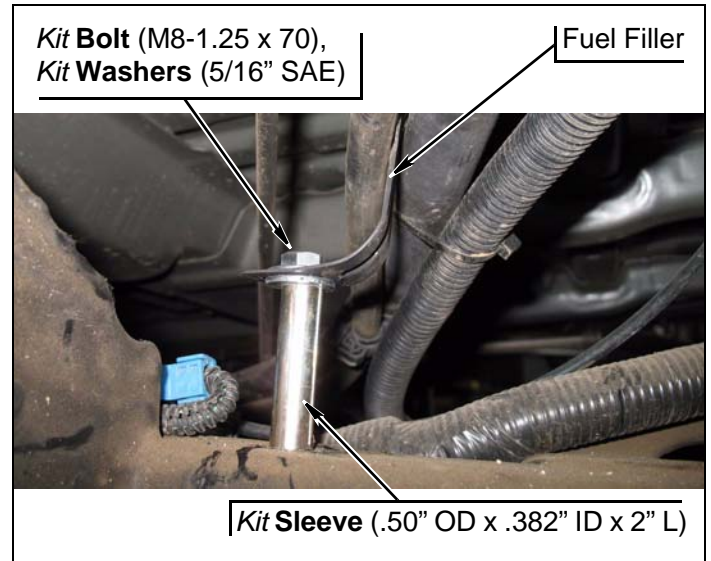

⚠ WARNING

Use extreme caution when working near the fuel lines and the fuel tank. Clean up spilled fuel immediately. A spark could cause an explosion or fire resulting in serious personal injury and property damage.

Underside of Vehicle

- 1. Parking brake cable
 - a. Install *kit bracket* (parking brake) onto second left cab mount with O.E. bolt. Mark hole with center punch.

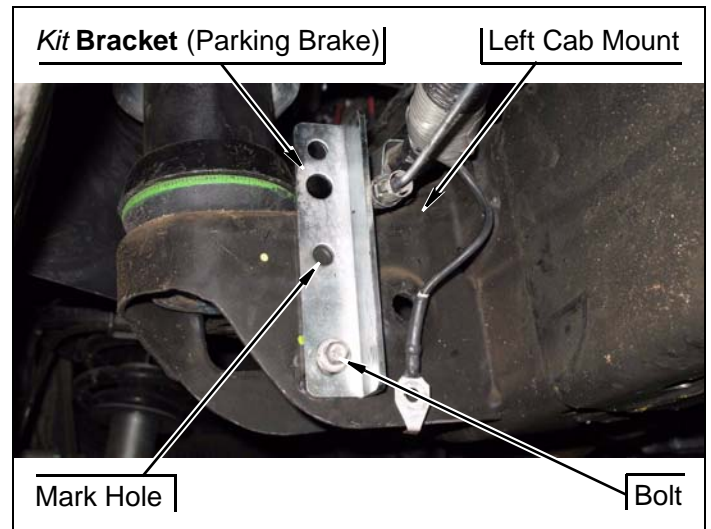

- b. Remove O.E. bolt and **kit bracket** (parking brake). Drill 3/8" hole through cab mount at marked location.

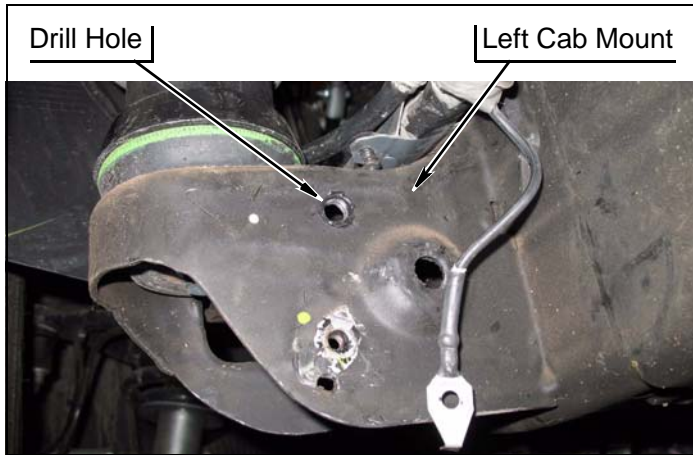

- c. Install **kit bracket** (parking brake) and ground strap onto cab mount with O.E. bolt, **kit bolt** (5/16"-18 x 1"), two **kit washers** (5/16" SAE) and **kit nut** (5/16" Nylock).
- d. Route parking brake cable through **kit bracket** (parking brake) and connect front and rear brake cables with junction.

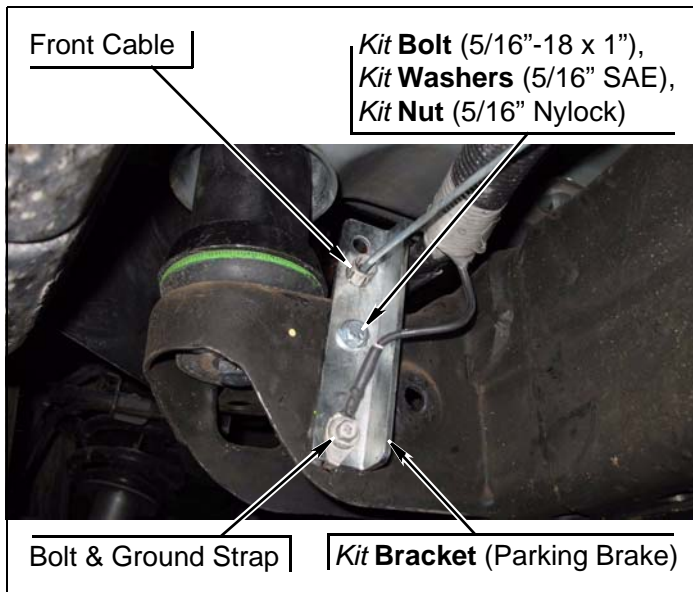

- e. Remove locking pliers from rear cable.
2. Install wiring harness and metal clip onto right frame rail with bolt.

3. Carefully bend metal transmission cooler lines so they do not interfere or contact belt tensioner or pulley.

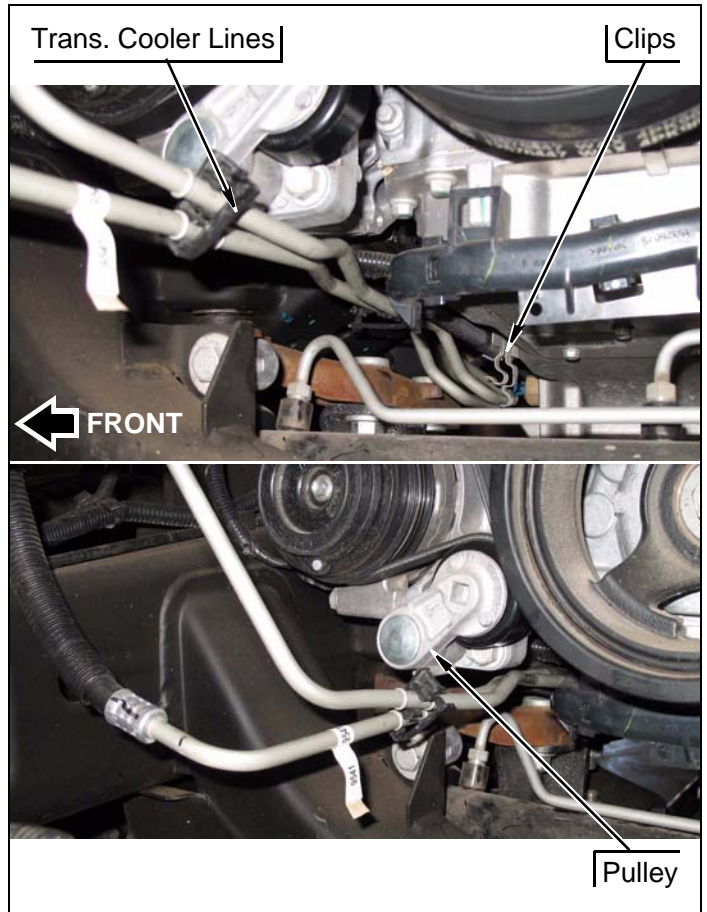

Engine Compartment

1. Steering shaft



⚠ WARNING

Verify the steering extension is securely installed as specified in the instructions. Failure to do so may cause steering malfunction, resulting in property damage or serious personal injury.

- a. Install **kit extension** (steering) onto lower steering shaft. Ensure marks on upper steering shaft and lower steering shaft are aligned.

- b. Install upper steering shaft onto **kit extension** (steering), ensuring marks on upper steering shaft and lower steering shaft are aligned.
- c. Apply a small amount of **kit Loctite®** onto O.E. bolt and **kit bolt** (3/8"-16 x 1-3/4").

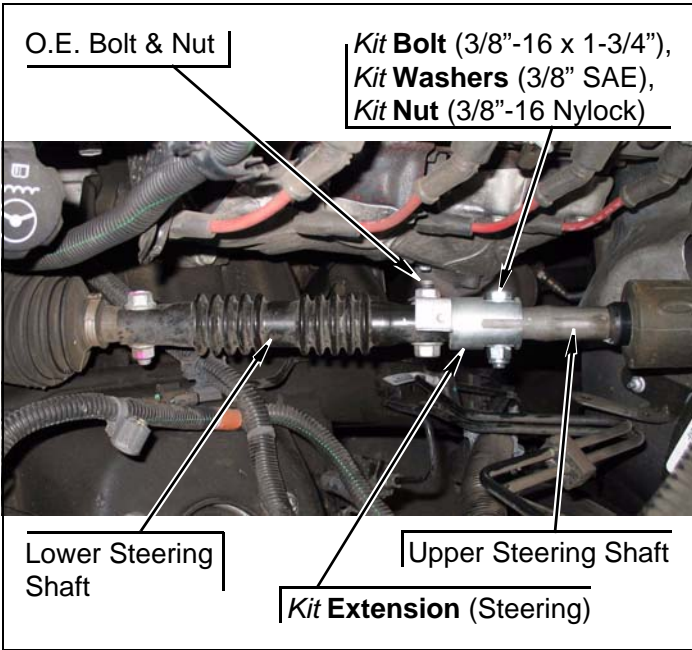

- d. Install **kit bolt** (3/8"-16 x 1-3/4") onto upper steering shaft and **kit extension** (steering) with two **kit washers** (3/8" SAE) and **kit nut** (3/8" Nylock).
- e. Install O.E. bolt onto lower steering shaft and **kit extension** (steering) with O.E. nut.
- f. TIGHTEN bolts to **33 lb.-ft.**

- 2. Install **kit bracket** (3" w/ stud) onto left firewall stud with O.E. nut.
- 3. Install ground strap onto **kit bracket** (3" w/ stud) with **kit washer** (1/4" SAE) and **kit nut** (1/4" Nylock).

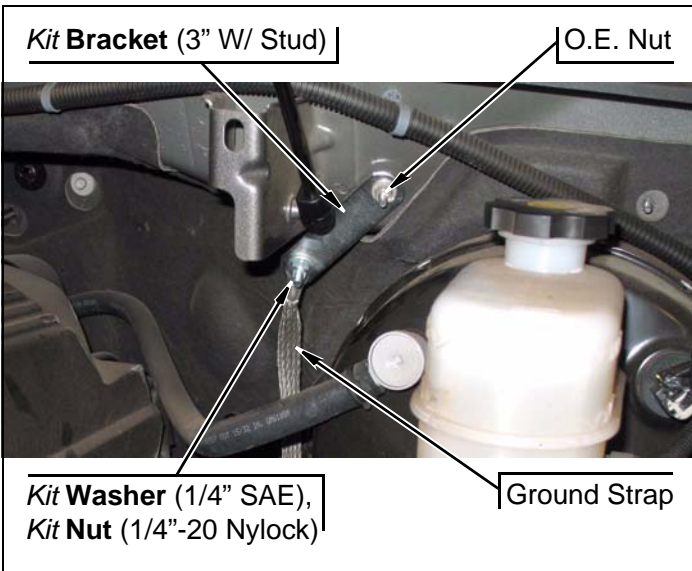

- 4. Install harness and metal clip onto right frame rail with bolt.

Front of Vehicle

- 1. Front bumper

- a. Mark and cut two bumper brackets as shown.

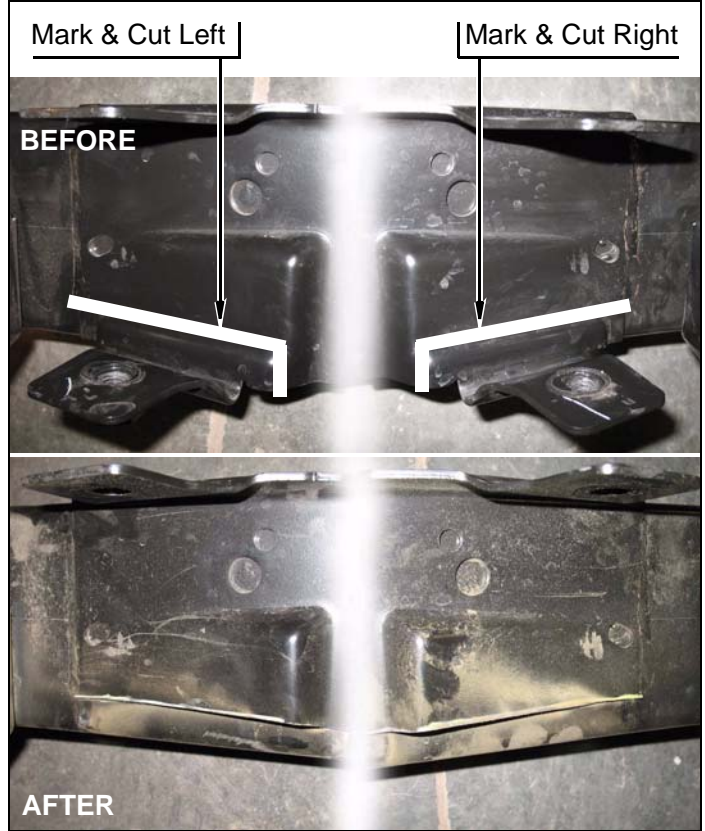

- b. Install two **kit sleeves** (.812" OD x .572" ID x 2.625" L), two **kit brackets** (bumper, front), two **kit bolts** (M14-2.0 x 210), four **kit washers** (M14), two **kit nuts** (M14-2.0 Stover) and bumper onto two frame horns.

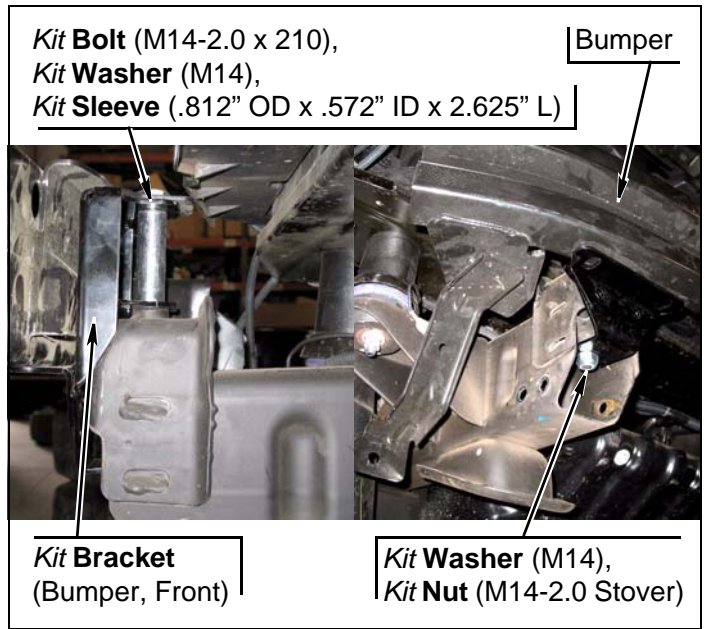

c. Mark outer hole through two *kit brackets* (bumper, front) with center punch.

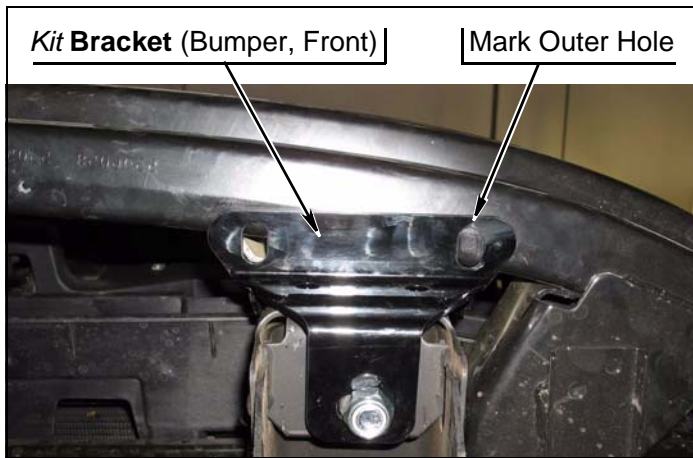

d. Drill two 7/16" holes through two *kit brackets* (bumper, front) into bumper.

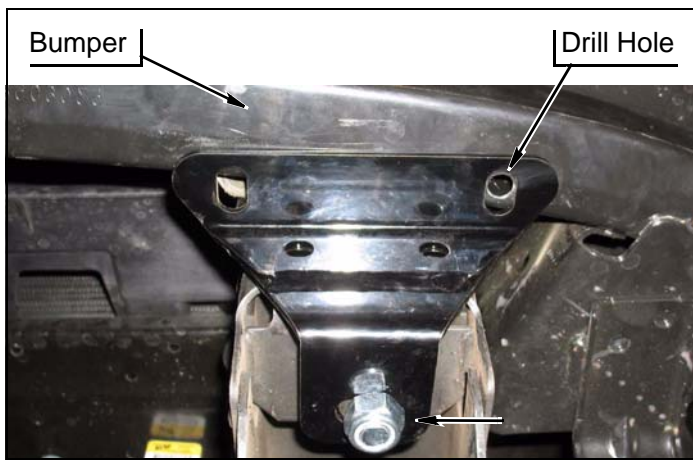

e. Using telescoping magnet, install *kit brackets* (bumper, front) onto bumper with two *kit bolts* (7/16"-14 x 1"), two *kit washers* (7/16" SAE) and two *kit nut plates*.

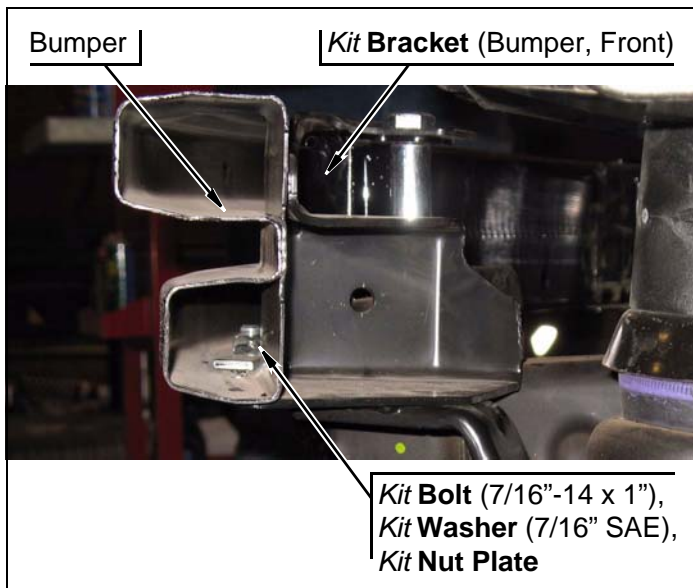

f. Position fascia onto vehicle. Mark location of frame horns as shown.

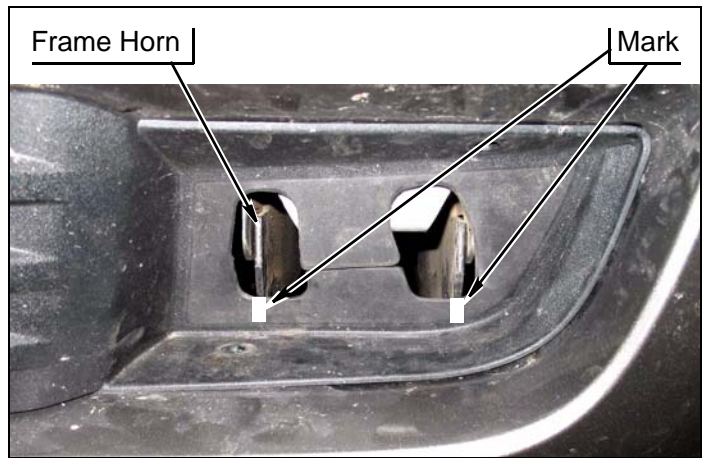

g. Mark and cut fascia tow hook access holes as shown.

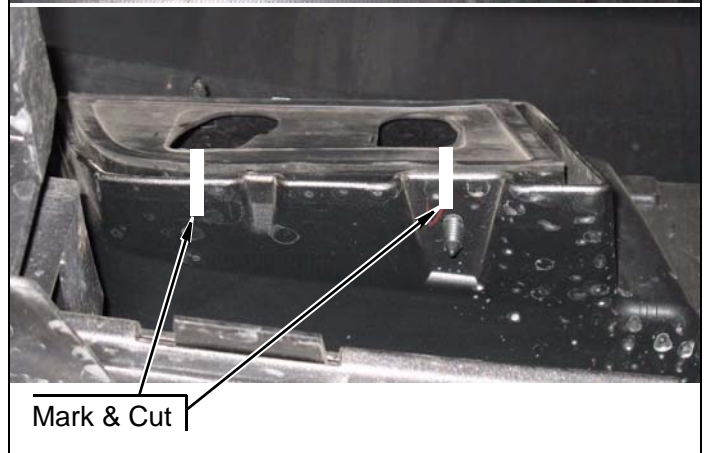
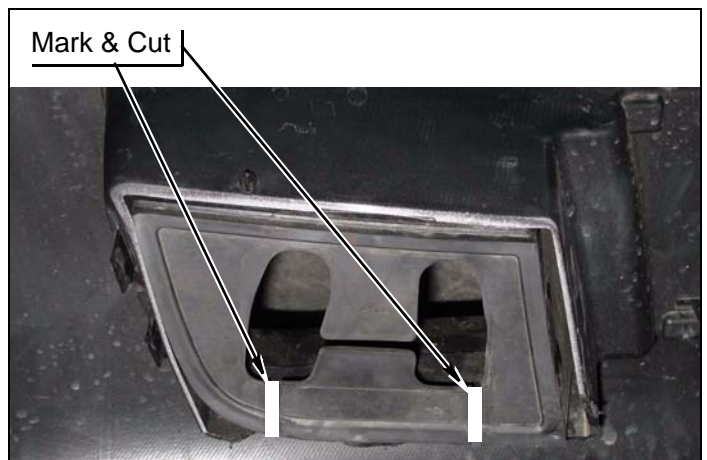

h. Mark and cut two fascia supports as shown.

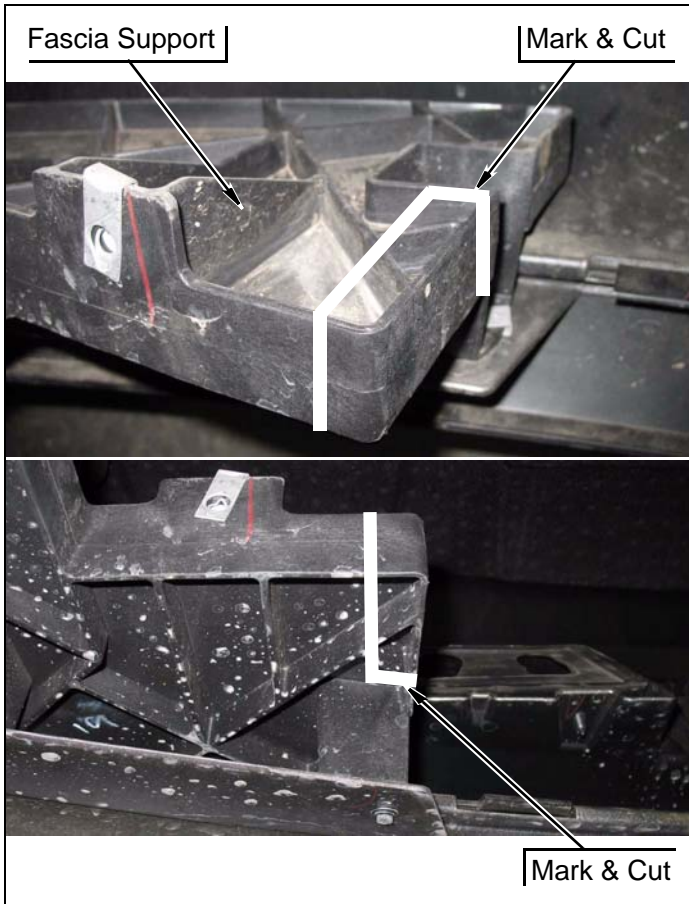

- i. Test fit fascia onto vehicle. Trim areas in previous two substeps as necessary.
- j. Install fascia onto core support with six bolts.
- k. Install left and right fascia clips onto two fenders.
- l. Install two fascia supports onto bumper with two bolts.
- m. Connect two wiring harnesses onto fog lamps, if equipped.

After Completing Installation

Engine Compartment

1. Connect both battery cables. Connect positive cable first, then negative cable.
2. Install airbag fuse and fuse block cover.

Miscellaneous

1. Apply *kit label* (warning) onto dashboard in plain sight of all vehicle occupants.
2. Check all fasteners to ensure they are tight.
3. Ensure all wires, hoses, cables, etc. are properly connected and there is ample slack.
4. Adjust headlights.

Dynamic Vehicle Check

1. Check steering in both directions to ensure that there is no bind. Check operation of clutch, brake system, and parking brake. Check operation of transmission and transfer case. Ensure there is full engagement in all gears and 4WD ranges. Check battery connections and electrical component operations. Test-drive vehicle.

⚠ WARNING

Retorque all fasteners after 500 miles and after off road use. All body lift components should be visually inspected and fasteners retorqued during routine vehicle servicing.

⚠ CAUTION

Performance Automotive Group does not recommend any particular wheel and tire combinations for use with its body lifts and cannot assume responsibility for the customer's choice of wheels and tires. Refer to your owner's manual for recommended tire sizes and warnings related to the use of oversized tires. Larger wheel and tire combinations increase stress and wear on steering and suspension components, which leads to increased maintenance and higher risk for component failure. Larger wheel and tire combinations also alter speedometer calibration, braking effectiveness, center of gravity, and handling characteristics. Consult an experienced local off road shop to find what wheel and tire combinations work best with your vehicle.

NOTE

All warranty information, instruction sheets, and other documents regarding the installation of this product must be retained by the vehicle owner. Information contained in the instructions and on the warranty card will be required for any warranty claims. The vehicle owner needs to understand the modifications made to the vehicle and how they affect vehicle handling and performance. Failure to provide the customer with this information can result in damage to the vehicle and severe personal injury.

Accessories

Kit# 6546 Gap Guards

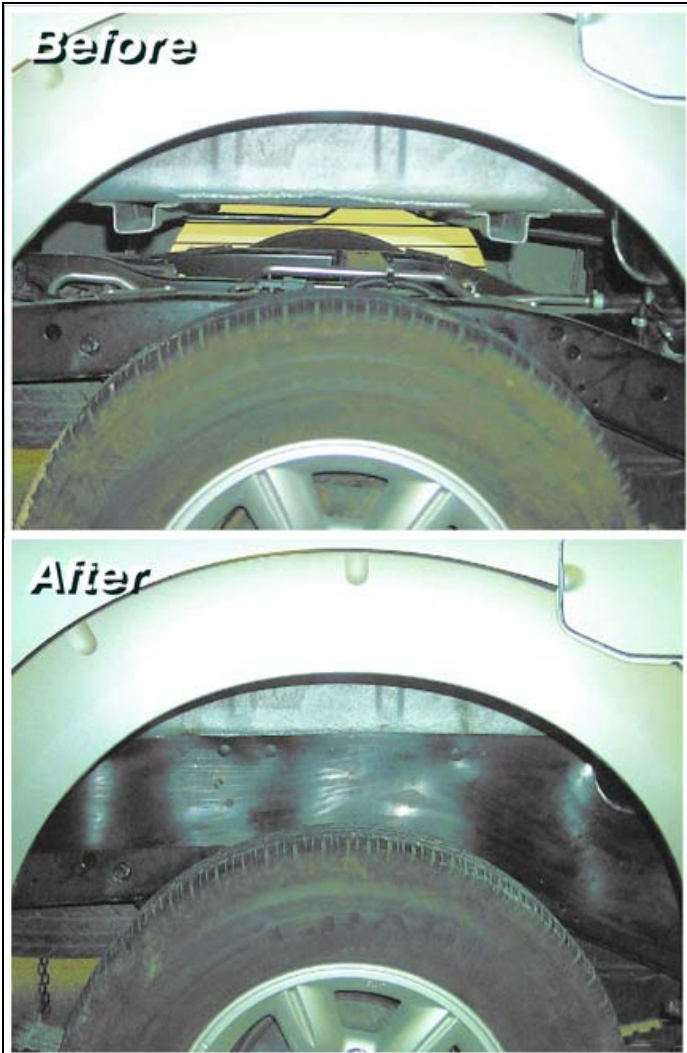

Kit Parts List

Qty. Description

12	Block
2	Bracket (bumper, front)
1	Bracket (bumper, rear, left)
1	Bracket (bumper, rear, right)
1	Bracket (bumper, rear, support, left)
1	Bracket (bumper, rear, support, left)
1	Label (logo)
1	Label (warning)
1	Loctite® (6ml bottle)
1	BP10183 (Bolt pack)
2	Bolt (M12-1.75 x 180)
10	Bolt (M14-2.0 x 180)
2	Bolt (M14-2.0 x 210)
1	Bolt (3/8"-16 x 1-3/4")
4	Bolt (1/2"-13 x 4-1/2")
1	Bracket (parking brake)
1	Extension (steering)
1	Nut (3/8"-16 Nylock)
2	Sleeve (.75" OD x .532" ID x 2.43" L)
2	Sleeve (.812" OD x .572" ID x 2.625" L)
2	Washer (3/8" SAE)
1	HP10183 (Hardware pack)
1	Bolt (M8-1.25 x 70)
1	Bolt (5/16"-18 x 1")
2	Bolt (7/16"-14 x 1")
14	Bolt (1/2"-13 x 1-1/2")
1	Bracket (3" with stud)
1	Nut (1/4"-20 Nylock)
1	Nut (5/16"-18 Nylock)
18	Nut (1/2"-13 Nylock)
2	Nut plate
2	Nut (M14-2.0 Nylock)
1	Sleeve (.50" OD x .382" ID x 2" L)
1	Washer (1/4" SAE)
4	Washer (M14)
2	Washer (5/16" SAE)
2	Washer (5/16" USS)
36	Washer (1/2" SAE)
2	Washer (7/16" SAE)