



3651 N Highway 89 • Chino Valley, AZ 86323
(928) 636-7080 • www.p-a-g.net

**NISSAN FRONTIER 2 & 4WD
AUTOMATIC & MANUAL TRANS.
KING & CREW CAB MODELS
(CHROME FRONT BUMPER ONLY)
3" BODY LIFT KIT
INSTALLATION INSTRUCTIONS
2005-2006 KIT# 40083**

⚠ WARNING
Installation of a Performance Automotive Group body lift kit will change the vehicle's center of gravity and handling characteristics both on- and off-road. You must drive the vehicle safely! Extreme care must be taken to prevent vehicle rollover or loss of control, which could result in serious injury or death. Avoid sudden sharp turns or abrupt maneuvers and always make sure all vehicle occupants have their seat belts fastened.

⚠ WARNING
Before you install this kit, read and understand all instructions, warnings, cautions, and notes in this instruction sheet and in the vehicle owner's manual.

⚠ CAUTION
Proper installation of this kit requires knowledge of the factory recommended procedures for removal and installation of original equipment components. We recommend that the factory shop manual and any special tools needed to service your vehicle be on hand during the installation. Installation of this kit without proper knowledge of the factory recommended procedures may affect the performance of these components and the safety of the vehicle. We strongly recommend that a certified mechanic familiar with the installation of similar components install this kit.

⚠ WARNING
DO NOT combine suspension, body, or other lift devices. Use of vehicle with combined lifts may result in unsafe and/or unexpected handling characteristics.

⚠ WARNING
This kit should only be installed on a vehicle that is in good working condition. Before you install the kit, thoroughly inspect the vehicle for corrosion or deformation of the sheet metal around the factory body mounts. If the vehicle is suspected to have been in a collision or misused, do not install this kit. Off-road use of your vehicle with this kit installed may increase the stress applied to the factory body mounts. We do not recommend that any vehicle with a body lift kit installed be involved in any extreme off-road maneuvers such as jumping. Failure to observe this warning may result in serious personal injury and/or severe damage to your vehicle.

⚠ WARNING
Many states and municipalities have laws restricting bumper heights and vehicle lifts. Consult state and local laws to determine if the changes you intend to make to the vehicle comply with the law.

⚠ WARNING
The installation of larger tires may reduce the effectiveness of the braking system.

⚠ WARNING
Always wear eye protection when operating power tools.

⚠ WARNING
Before you install this kit, block the vehicle tires to prevent the vehicle from rolling.

⚠ WARNING
Accidental deployment of the air bag can result in serious personal injury or death. To avoid accidental deployment during installation of the kit, the Supplemental Restraint System (SRS, or airbag) must remain deactivated. Do not allow anyone near the airbag during installation. Refer to the factory service manual or owner's manual for the recommended procedure to disable the SRS. After you install the kit, reactivate the SRS before driving the vehicle.

NOTE
Performance Automotive Group recommends using the Loctite® supplied in the kit on the threads of all kit nuts and bolts unless specified otherwise in these instructions.

Before Starting Installation

NOTE

Kit parts are prefaced by the word *kit* and appear in **bold** print.

1. Carefully read all warnings and instructions completely before beginning.
2. Verify all parts have been received in this kit by checking the parts list at the end of this document.

NOTE

If parts are missing from kit, please be prepared to provide the following information:

1. **Name** of purchase location
2. **Bar Code** on side of box
3. **Date** above bar code
4. **Date** inside box cover
5. **Inspector #** from inside box cover

3. **Only install this kit on the vehicle for which it is specified.** If anytime during the installation you encounter something different from what is outlined in the instructions, call technical support at (928) 636-7080.

4. Special tools needed:

- a. Welder or access to a professional welding shop.
- b. Die grinder or similar tool capable of cutting metal.
- c. Saws All or similar reciprocating cutting blade tool.

5. Park vehicle on a clean, dry, flat, level surface and block tires so vehicle cannot roll in either direction.

Engine Compartment

1. Disconnect both battery cables. Disconnect negative cable first, then positive cable.
2. Remove battery tie-downs and battery from vehicle and place on floor or ground.

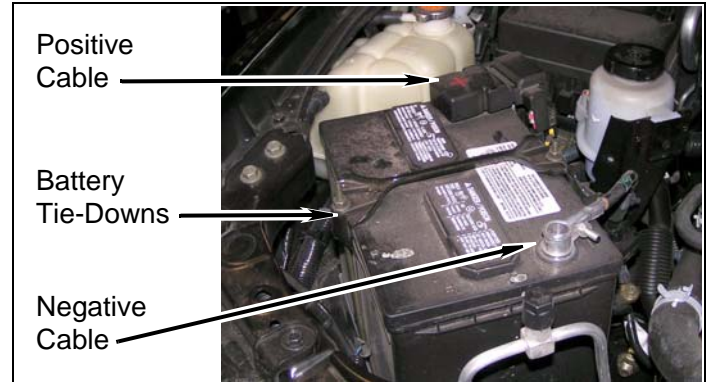

Inside Cab

1. Airbag Fuse

NOTE

The location of the airbag fuse may vary; check the owner's manual.

- a. Remove fuse cover.
- b. Remove airbag fuse.

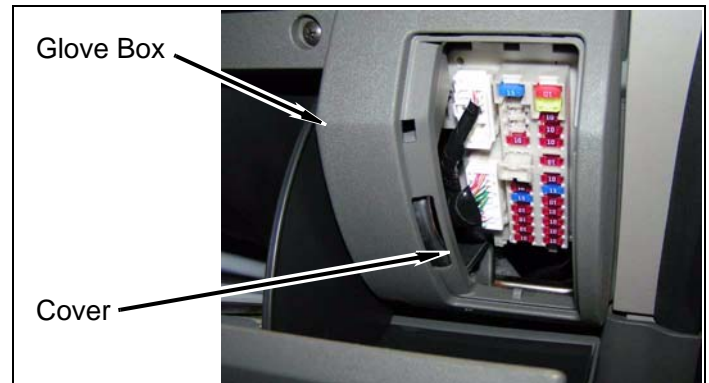

Prepare to Install Kit

Measurements

1. Measure and record distance between front bumper and fenders.

Driver Side _____ Passenger Side _____

2. Measure and record distance between rear bumper and bed

Driver Side _____ Passenger Side _____

3. Measure and record distance between cab and bed.

Driver Side _____ Passenger Side _____

Front of Vehicle

1. Grill

- a. Remove six pop-up clips from top of grill and core support.

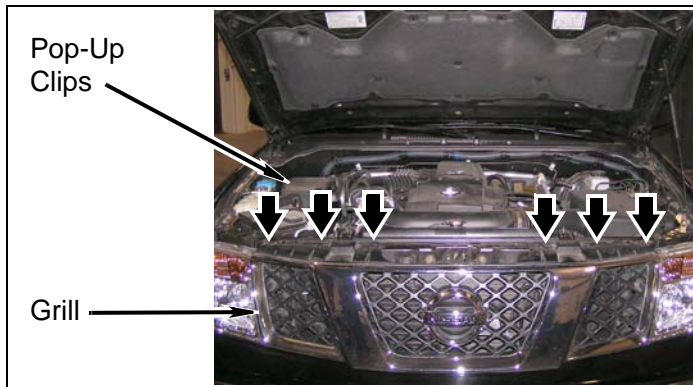

- b. Turn four turn clips 45°, depress four lower clips, and remove grill from core support.

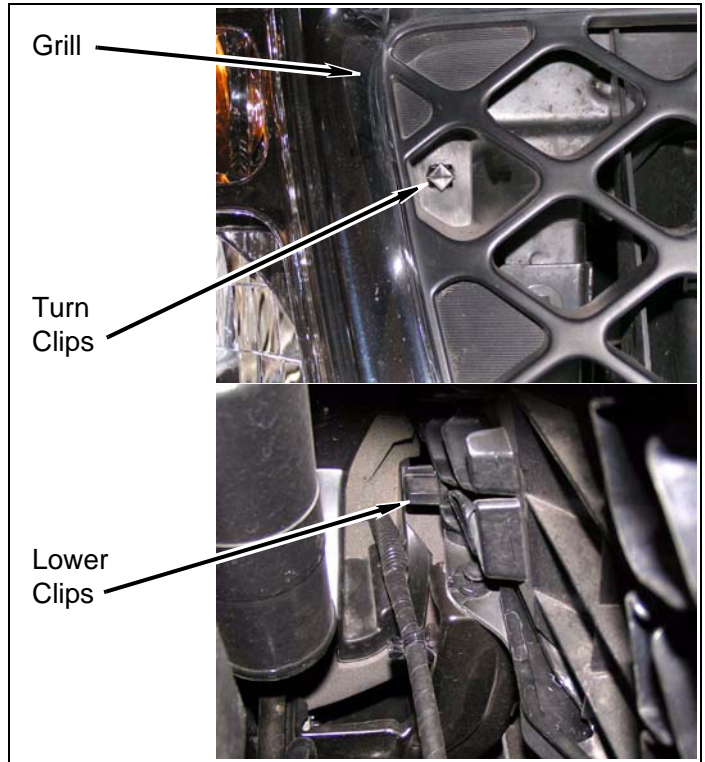

2. Front Bumper

- a. Remove four screws and two bolts and lower fascia from fascia.

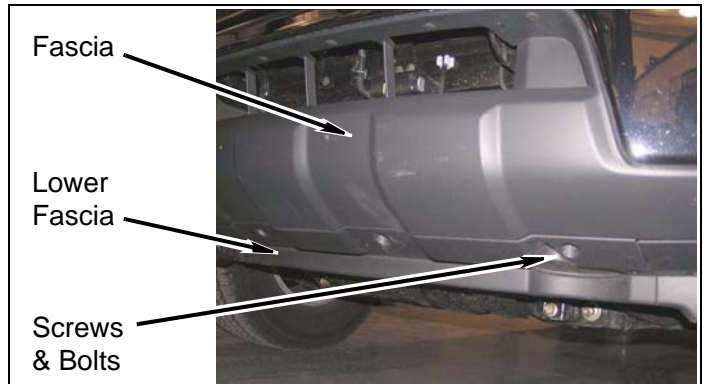

- b. Remove four bolts from fascia and skid plate.

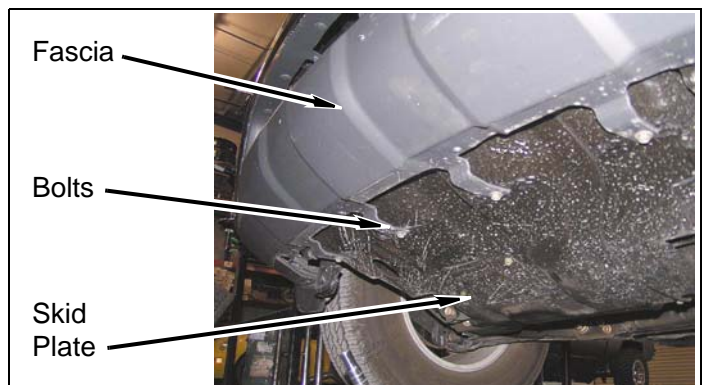

c. Remove four bolts and skid plate from front bumper and crossmember.

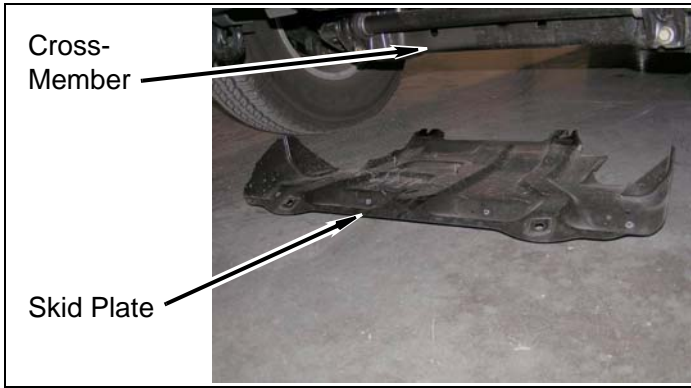

d. Disconnect two fog light wiring harnesses, if equipped.

e. Remove two bolts and two side supports from driver and passenger inside front bumper.

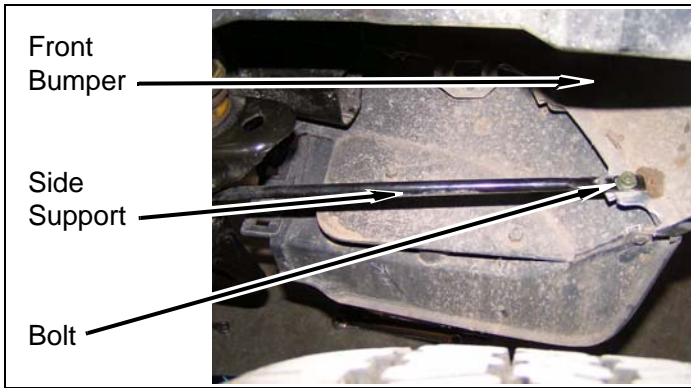

f. Remove six bolts (four upper and two lower) and front bumper from core support and bumper support.

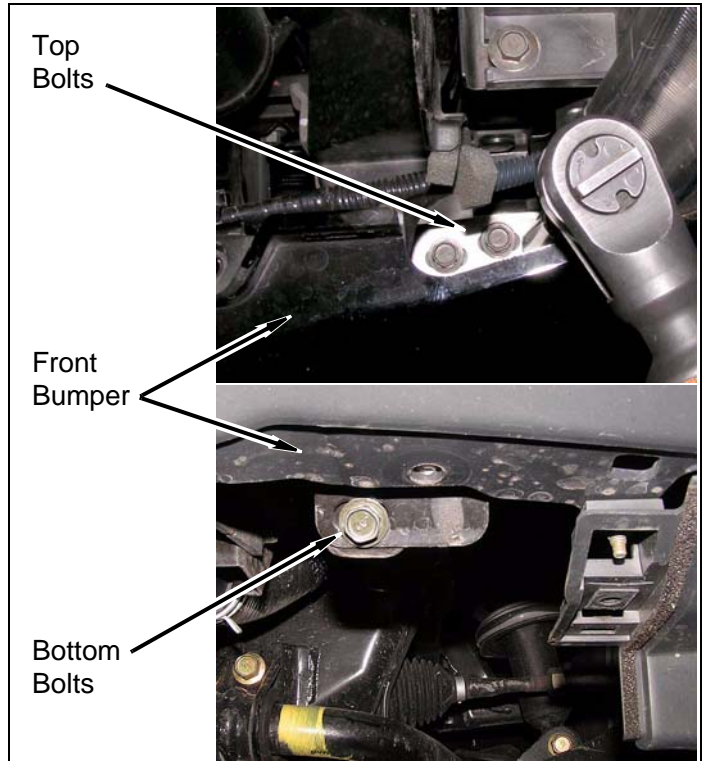

g. Remove four bolts and bumper support from frame rails.

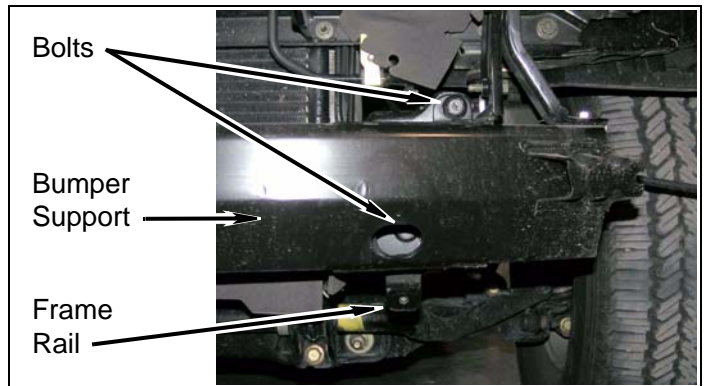

Engine Compartment

1. Airbox

a. Disconnect wiring harness from airbox cover.

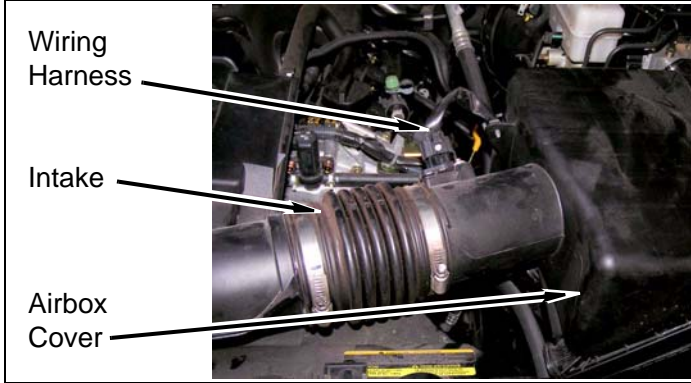

b. Remove two bolts and engine cover from engine.

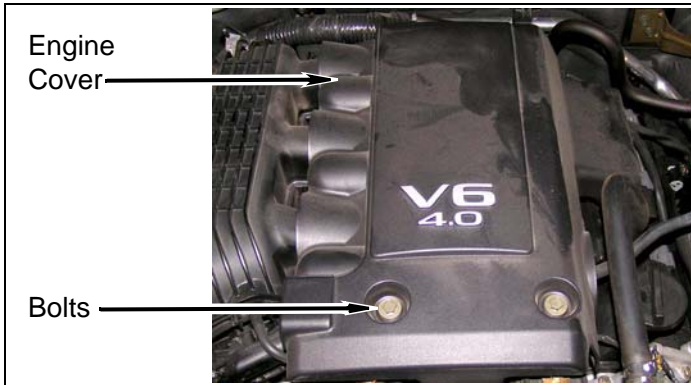

c. Remove clamp and vent hose from intake chamber.

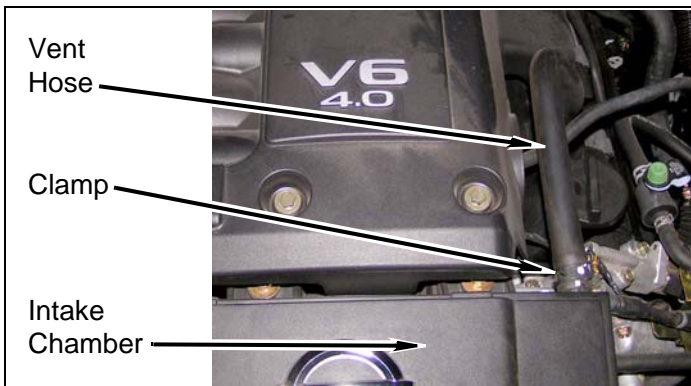

d. Remove two bolts from intake chamber.

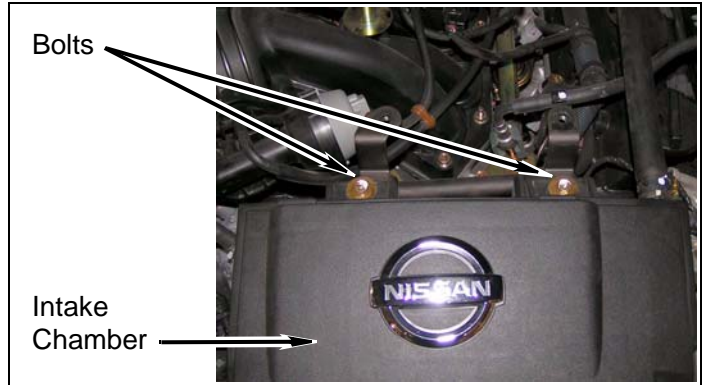

e. Loosen clamps on intake and throttle body and remove intake.

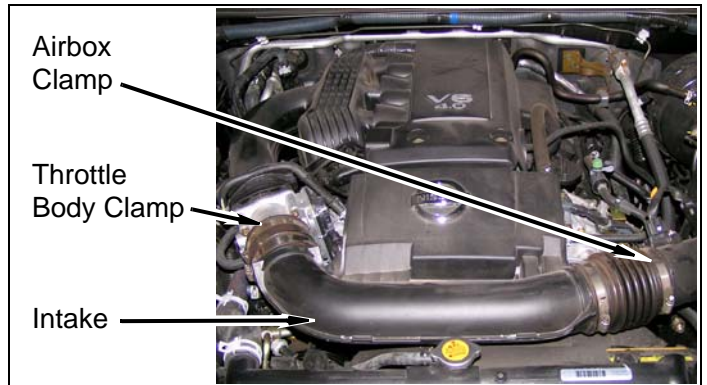

f. Remove two clips, airbox cover, and airbox filter.

2. Remove two nuts and metal heater core tube from firewall.

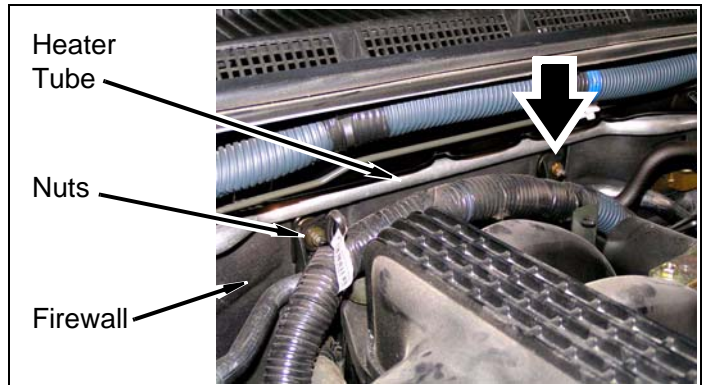

3. Remove two bolts, bracket, and AC line from driver side firewall.

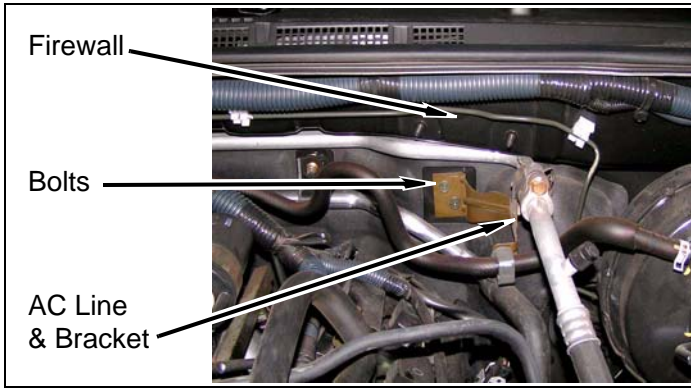

c. Remove clamp and overflow hose from radiator.

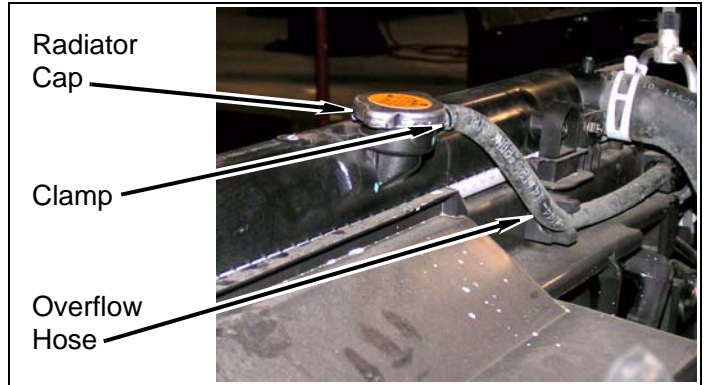

4. Fan shroud & radiator

⚠ WARNING
 If the engine cooling system is hot, the coolant will be HOT and UNDER PRESSURE. To prevent serious personal injury, wait until the cooling system is completely cool before removing the cap and/or hoses from the radiator.

a. Remove two bolts and two brackets from radiator and top of core support.

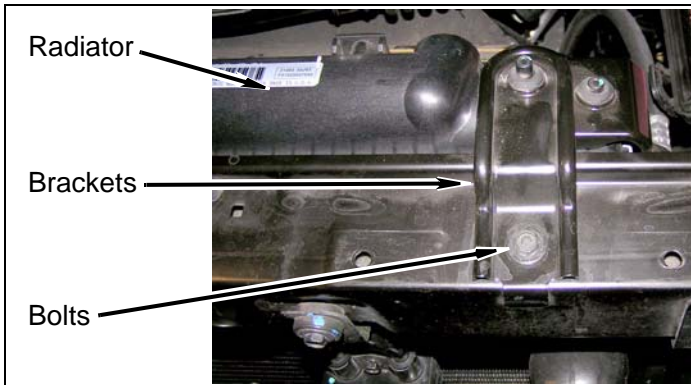

d. Remove three bolts from fan shroud, electric fan, and top of radiator.

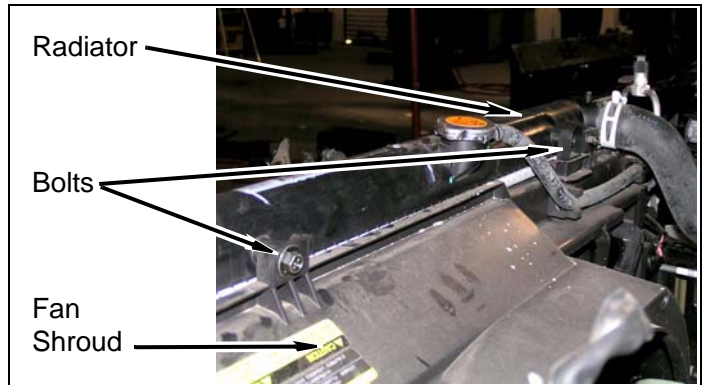

e. Depress two clips along bottom of fan shroud and remove lower fan shroud.

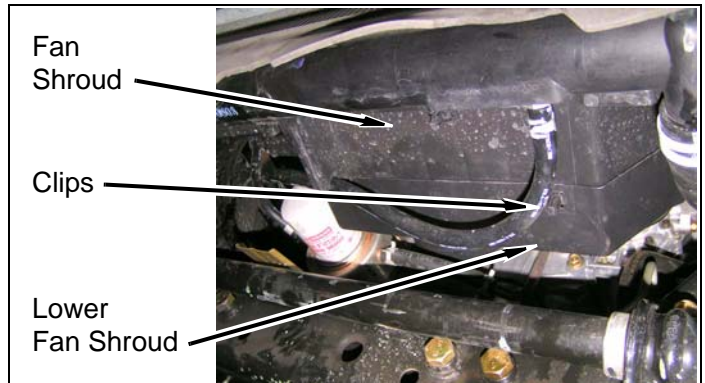

b. Disconnect and remove two wiring harnesses from electric fan and AC condenser.

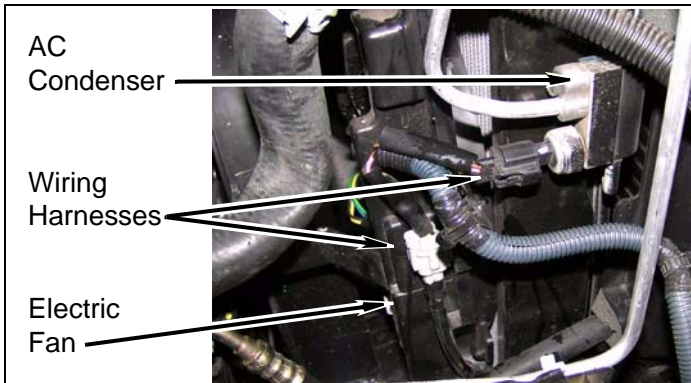

- f. Remove four nuts, fan clutch, and fan from pulley.

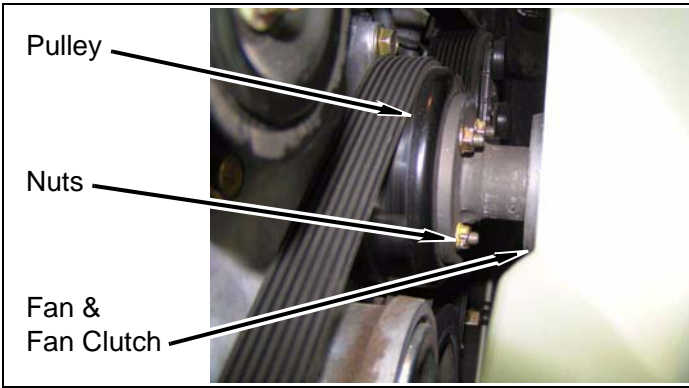

NOTE
Pulley may shift due to belt tension. This will not harm any components.

- g. Position clean drain pan or bucket beneath radiator stopcock.

⚠ WARNING
If the engine cooling system is hot, the coolant will be HOT and UNDER PRESSURE. To prevent serious personal injury, wait until the cooling system is completely cool before removing the cap and/or hoses from the radiator.

- h. Remove radiator cap.
- i. Open radiator stopcock and drain coolant into clean drain bucket or pan.

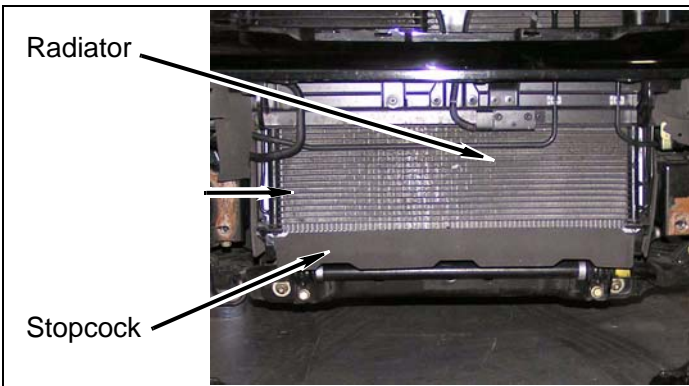

- j. Once all coolant has been drained, remove clamps, upper, and lower radiator hoses.

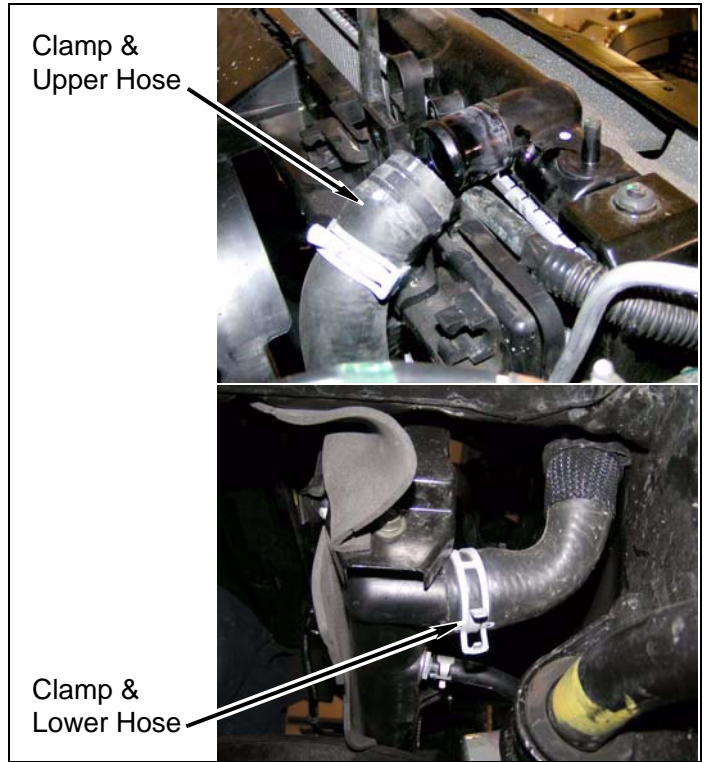

- k. Remove two clamps and two transmission coolant lines, if equipped, from bottom of radiator.

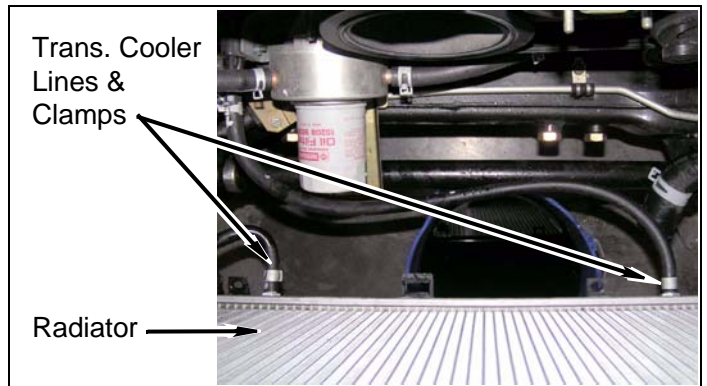

- l. Remove any hoses clipped onto fan shroud.
- m. Pull fan shroud and electric fan up and out of vehicle.

n. Remove two bolts from AC condenser and upper radiator.

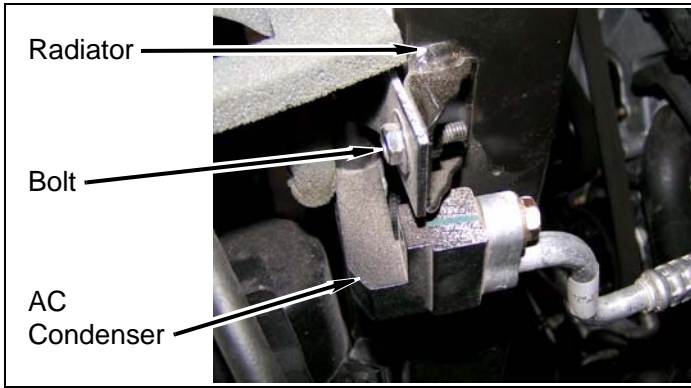

o. Using *kit ties*, hang AC condenser from upper core support.

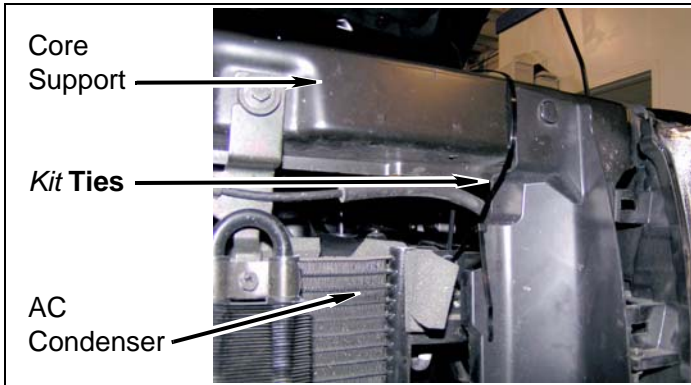

p. Pull radiator up and out of vehicle.

5. Power steering reservoir

a. Remove power steering reservoir from bracket.

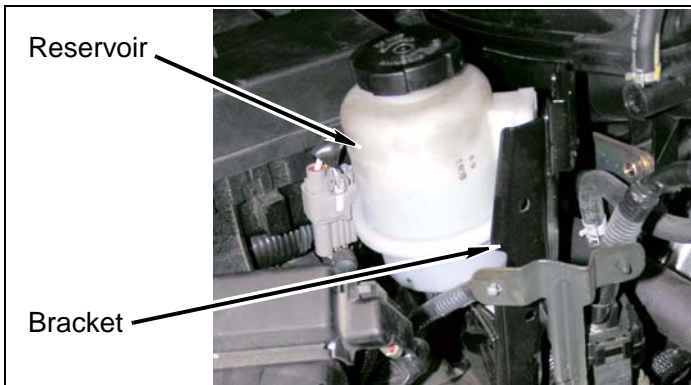

b. Remove three bolts and bracket from passenger side wheel well.

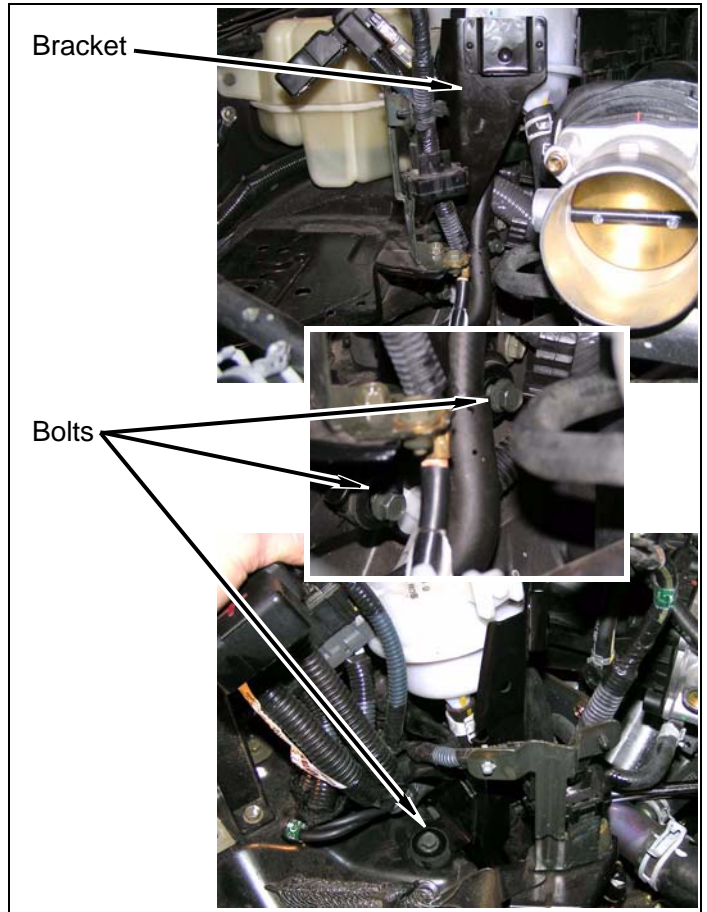

6. Engine wire harness

a. Remove or cut electrical tape covering wiring harness clip on passenger side wheel well.

b. Remove wiring harness from upper clip and lower clip located on passenger side engine bracket.

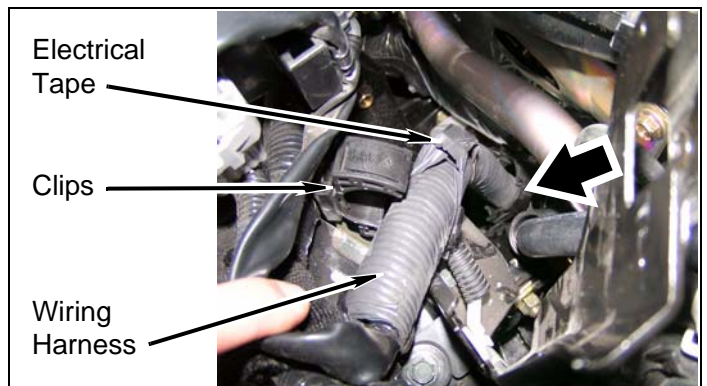

7. Remove bolt, power steering cooler line, and bracket from driver side frame rail.

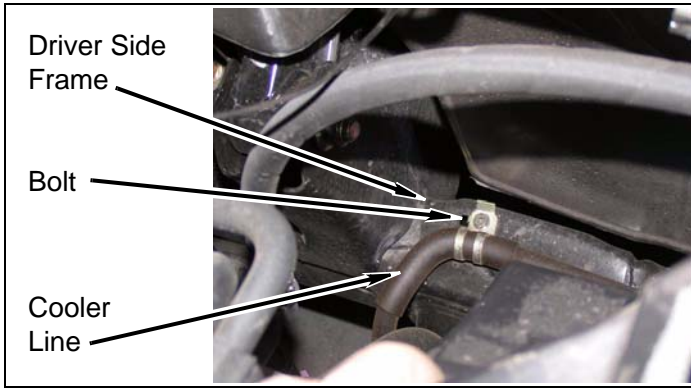

- c. Remove two bolts, two brackets, and ABS harnesses from two spring perch brackets.

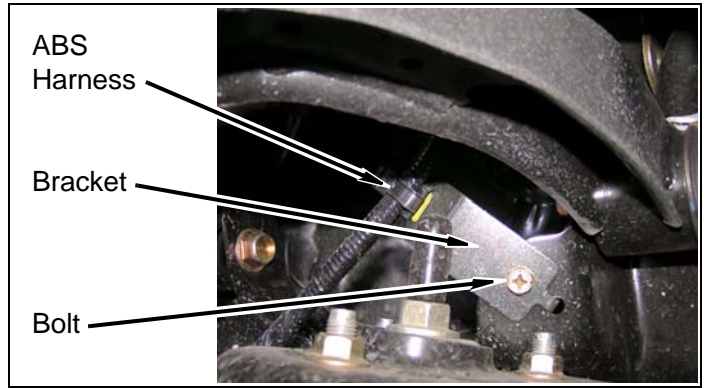

8. ABS sensors

- a. Remove or cut two ABS sensor harness clips from driver side wheel well.

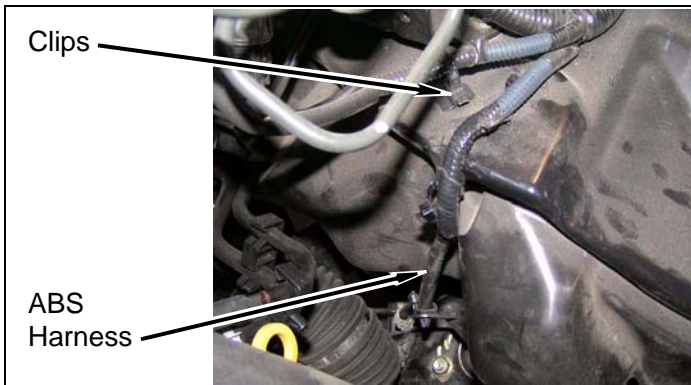

- b. Disconnect driver and passenger ABS sensor harnesses from two spring perches.

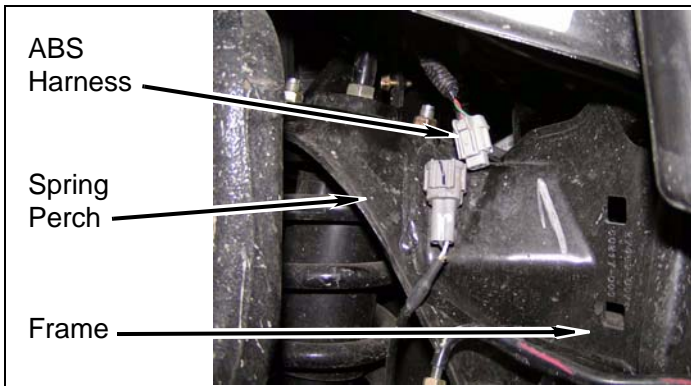

9. Steering Shaft

⚠ WARNING

Accidental deployment of the air bag can result in serious personal injury or death. To avoid accidental deployment during installation of the lift kit, the Supplemental Restraint System (SRS, or airbag) must remain deactivated. Do not allow anyone near the airbag during installation. Refer to the factory service manual or owner's manual for the recommended procedure to disable the SRS. After kit installation, the SRS must be reactivated before driving the vehicle.

⚠ CAUTION

If the following step is not performed, the airbag clockspring could be damaged. Do not turn the steering wheel while the steering shaft is disconnected.

- Strap steering wheel to prevent accidental movement.
- Mark lower steering shaft in relation to rack & pinion shaft as shown.
- Remove bolt and slide lower steering shaft up and off of rack & pinion shaft.

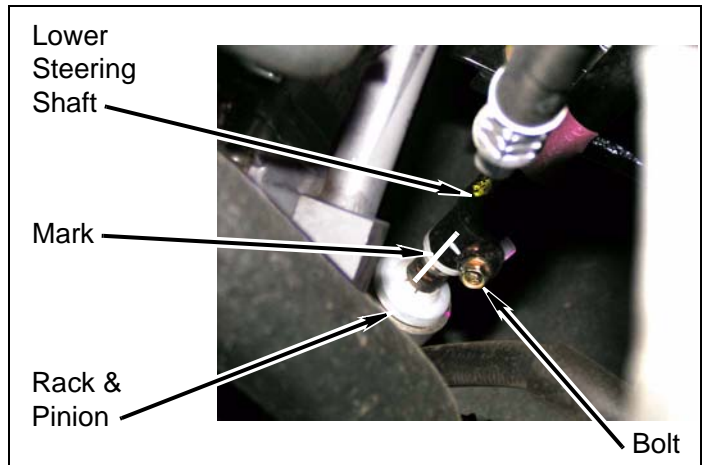

10. Remove two nuts and brake line bracket from lower driver side firewall.

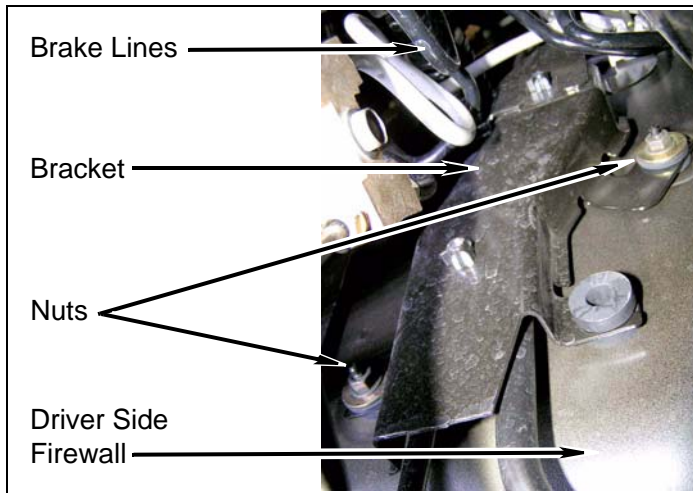

e. Remove four bolts and boot ring from floor.

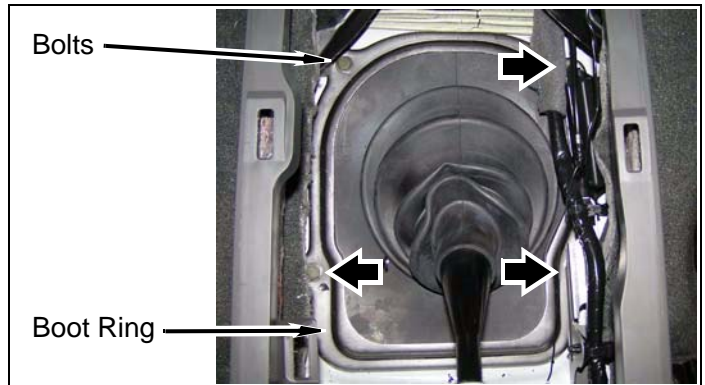

f. Remove two inner shift boots from shift lever and floor.

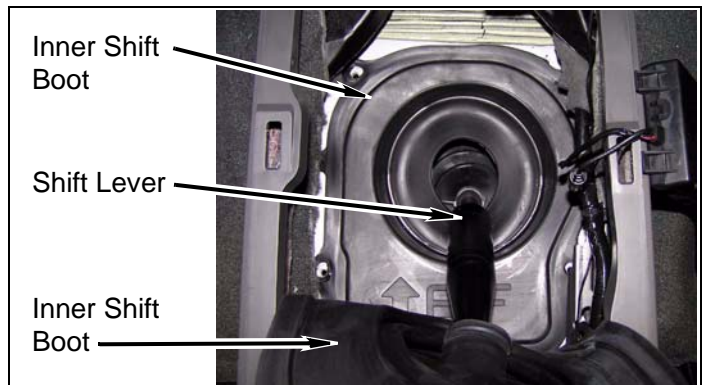

g. Remove two zip ties and shift tower boot from shift tower.

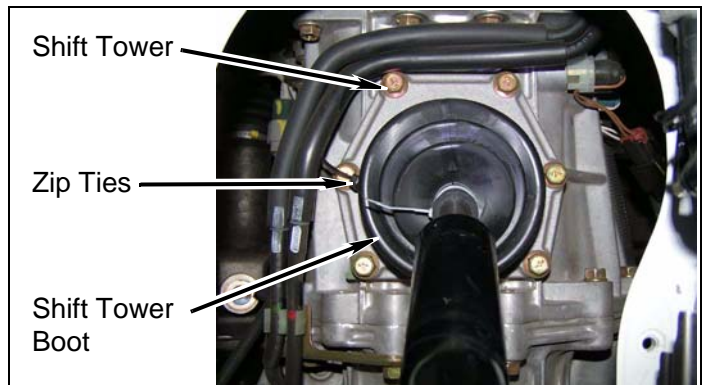

h. Remove three bolts and shift lever assembly from vehicle.

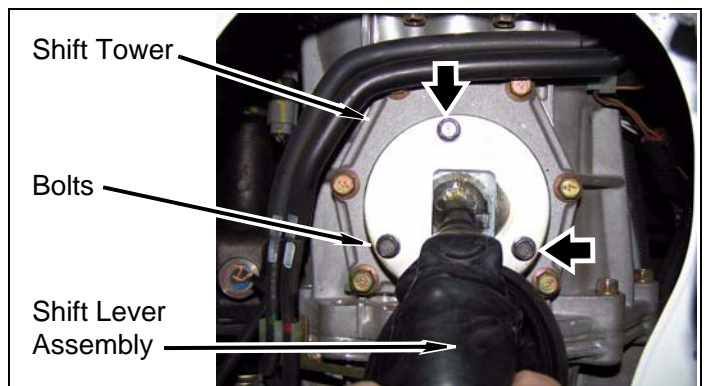

Inside of Vehicle

1. Manual transmission

- a. Pull up and remove cup holder trim panel from center console.
- b. Pull up and remove shift boot trim panel from center console.

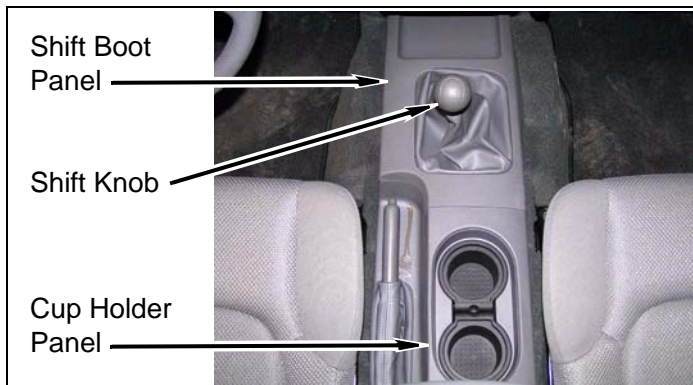

- c. Using pliers and rag (to protect shift knob) remove shift knob from shift lever.
- d. Remove bolt and wiring harness bracket from floor.

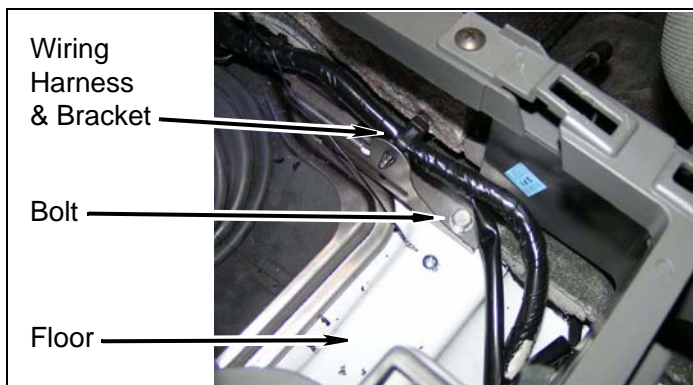

Underside of Vehicle

1. Wire harness

- a. Remove plastic cover from passenger side wiring harness behind front wheel.

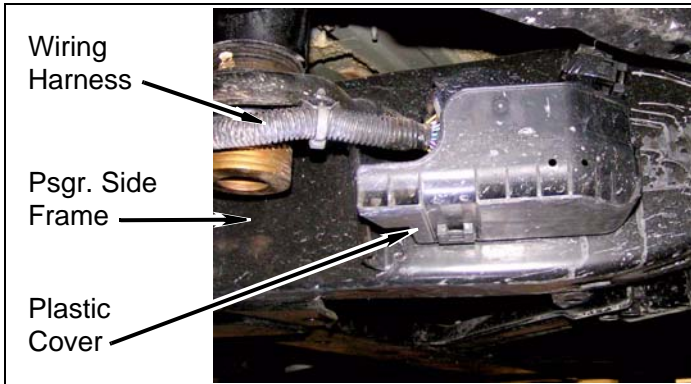

- b. Remove bolt, bracket, and wiring harness from frame rail.

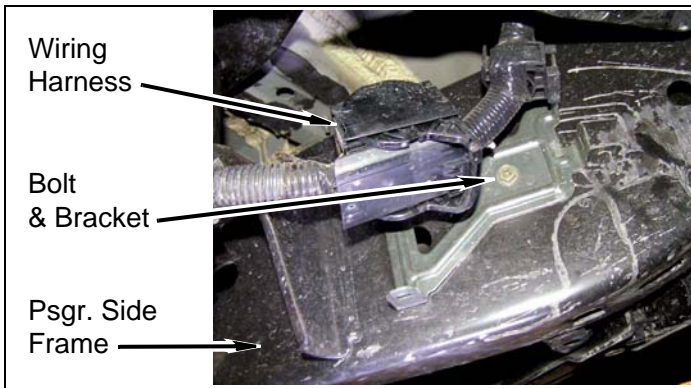

- ### 2. Remove two nuts and two parking brake cables from bottom center of cab.

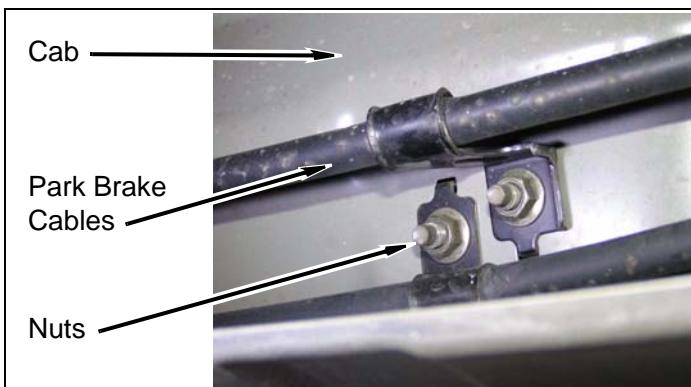

Rear of Vehicle

1. Fuel filler

- a. Open fuel door and remove fuel cap.

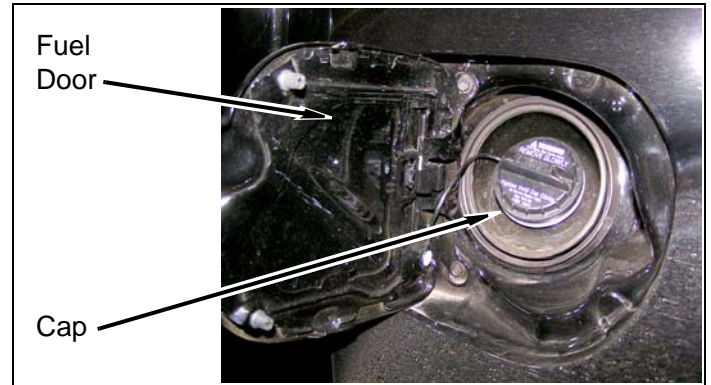

- b. Remove bolt and fuel filler from bed bracket.

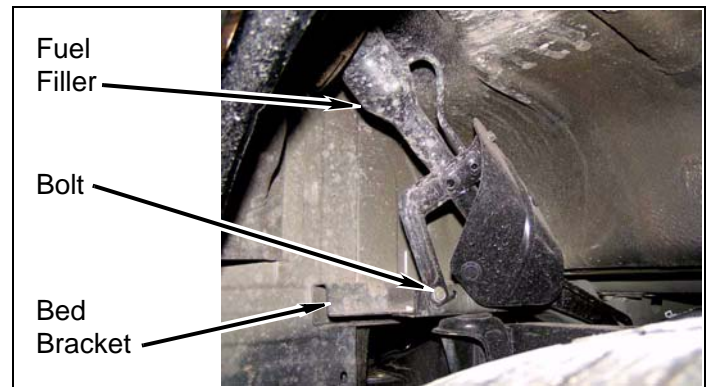

- c. Remove vent clip and hose from fuel filler vent tube.

- d. Remove two clips, clamp, filler hose, and fuel filler from fuel tank and vehicle.

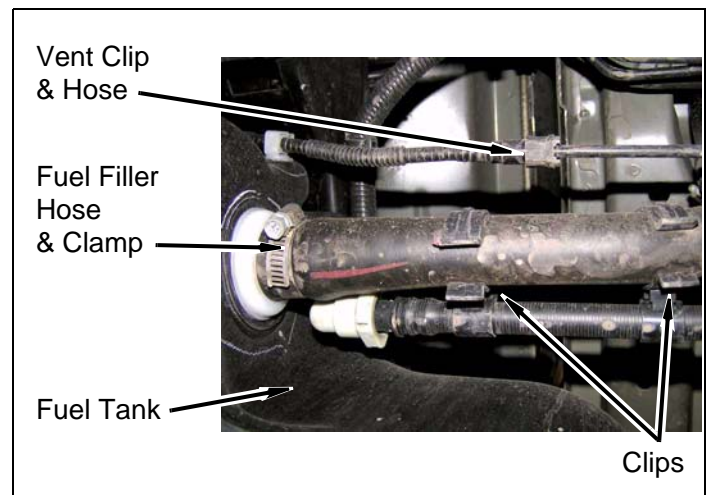

- ### 2. Remove nut and ground strap from exhaust.

3. Rear bumper

a. Remove wiring harness clip from bed rail.

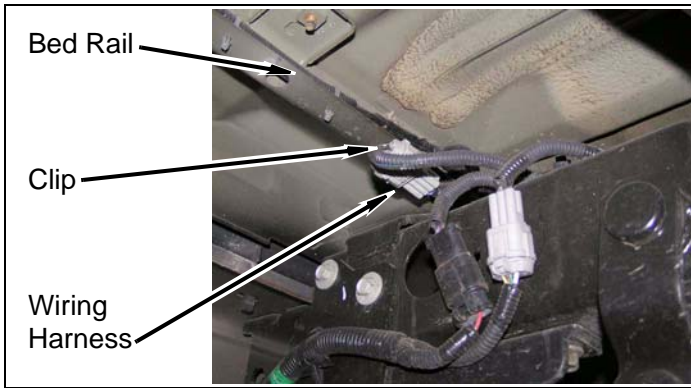

b. Disconnect two license plate wiring harnesses from rear bumper.

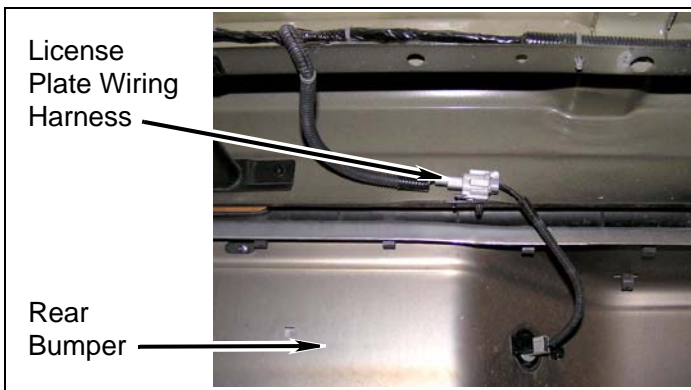

c. Remove six bolts and bumper from frame rails.

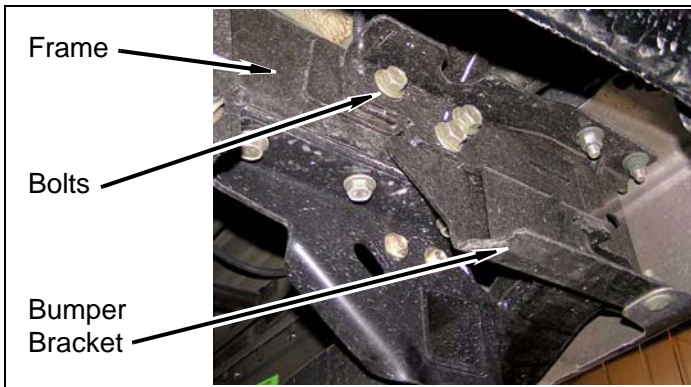

d. Depress clips and remove upper plastic step from bumper.

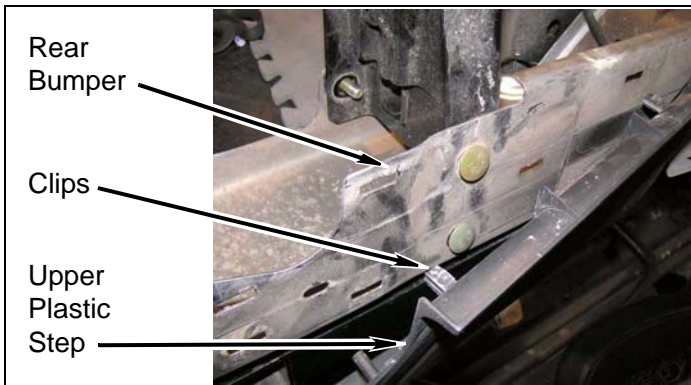

e. Depress clips and remove lower plastic step from bumper.

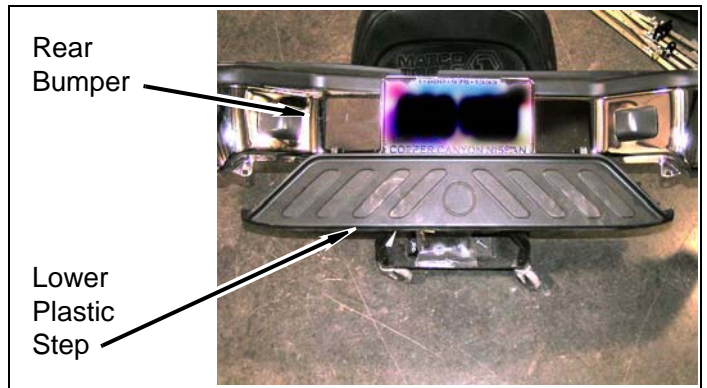

f. Remove six nuts, six studs, and bumper from bracket and crossmember.

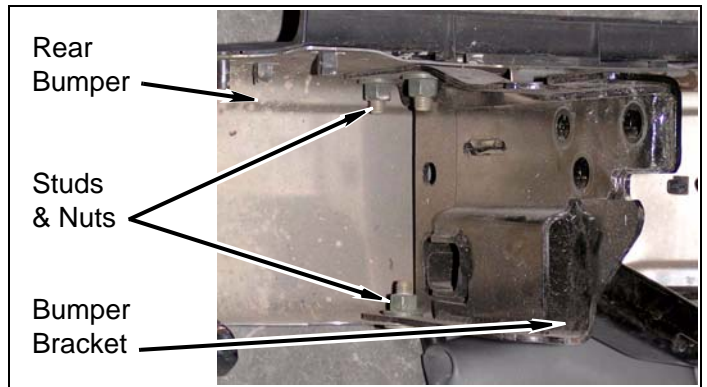

Install Kit

Cab

1. Prepare to lift cab from frame

a. Loosen, but DO NOT REMOVE, cab mounting bolts on driver side.

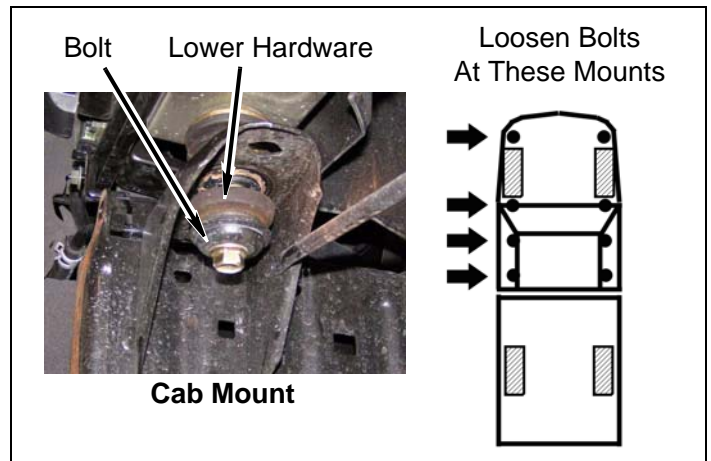

NOTE

The number of cab mounting bolts may vary with the length of the cab.

- b. Remove bolt and lower hardware from each cab mount on passenger side.

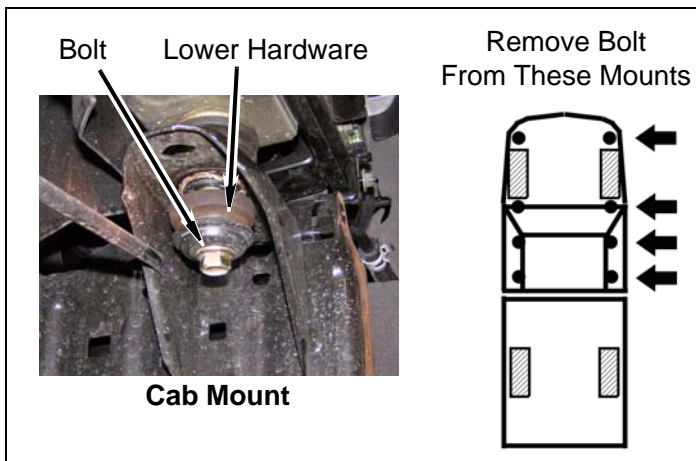

- b. Install **kit blocks** onto upper bushings on each cab mount as shown below.

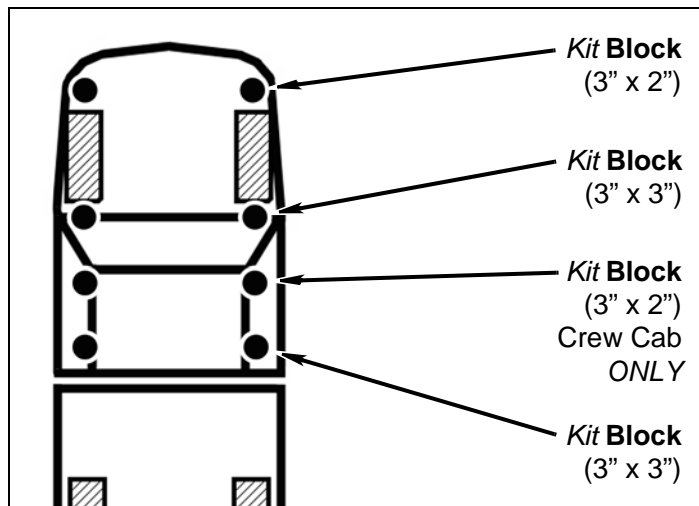

- c. Lower cab onto **kit blocks**.

- d. Install lower hardware and **kit bolt** (12mm x 180mm) on each cab mount. **DO NOT TIGHTEN.**

NOTE

Retain lower hardware from each cab mount. Lower hardware will be re-used.

⚠ WARNING

Use extreme caution when lifting body from frame. To prevent serious personal injury, ensure the lifting device is securely placed. Keep your hands out from between the body and frame.

⚠ CAUTION

Continually check hoses, wires, lines, etc. to be sure that everything is flexing properly and not binding, or damage to the vehicle could result. Be especially careful of the a/c hoses at the fire wall, the belt pulley, and at the core support. Ensure brake lines stretch while lifting. Bending the lines to gain ample slack may be necessary. Be extremely careful not to kink the lines.

2. Cab passenger side

- a. Position a hydraulic floor jack and a wood block under passenger side of cab (under the body seam). Slowly lift cab just enough to install a **kit block** on top of factory upper bushing.

⚠ WARNING

The **kit blocks** must be installed in addition to the factory upper and lower bushings. Installing the **kit blocks** without the factory upper and lower bushings could result in damage to the vehicle or serious personal injury.

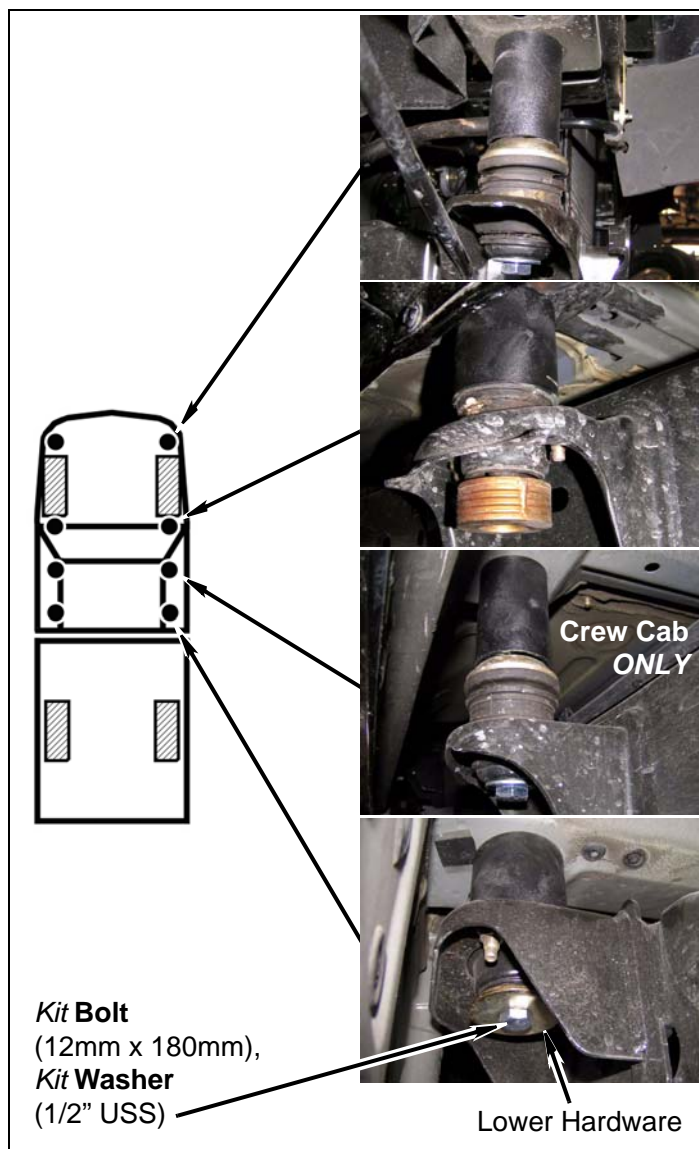

NOTE

Lower hardware varies between each body mount and can include rubber bushings and/or washers.

3. Cab driver side

- a. Repeat previous steps on driver side of cab.
- b. Set cab-to-bed spacing according to previous measurement.
- c. Remove each *kit bolt*, one at a time, and apply a small amount of *kit Loctite*® onto threads. Install *kit bolt*, *kit washer* (1/2" USS), and lower hardware. TIGHTEN *kit bolt* to 55 ft. lbs.

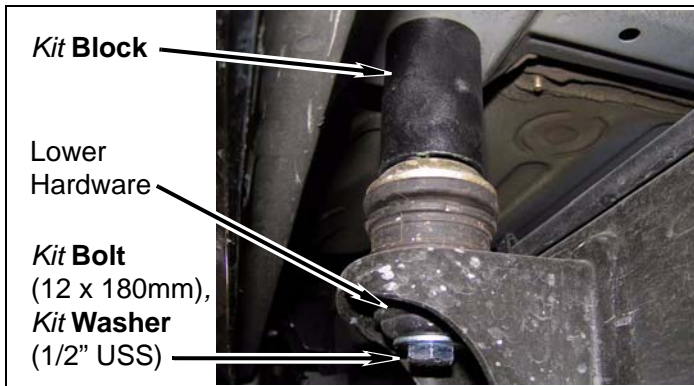

Bed

1. Prepare to lift bed from frame

- a. Loosen, but DO NOT REMOVE, bed mounting bolts on driver side.

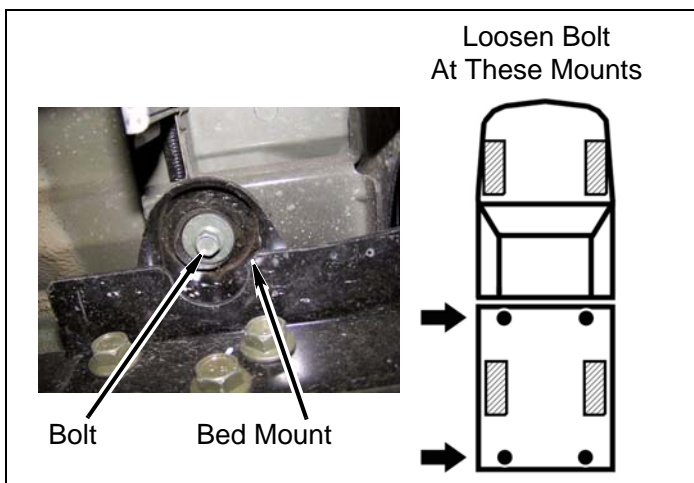

NOTE

The number of bed mounting bolts may vary with the length of the bed.

2. Remove bolt and washer from each bed mount on passenger side.

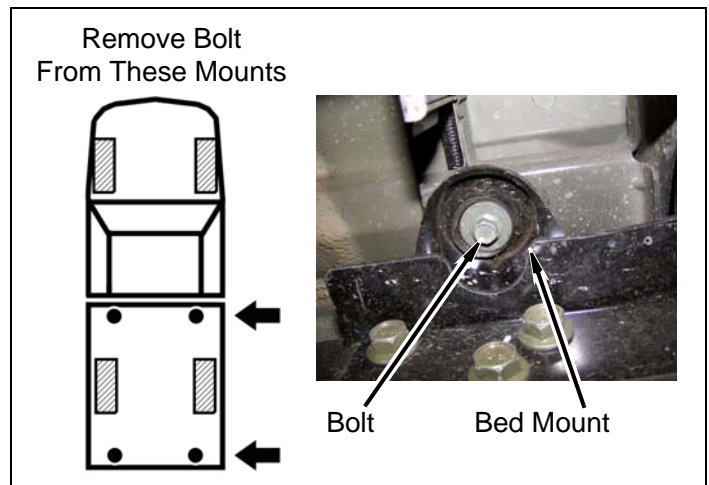

NOTE

Retain washer from each bed mount. Washers will be re-used.

⚠ WARNING

Use extreme caution when lifting the bed from the frame. To prevent serious personal injury, ensure the lifting device is securely placed. Keep your hands out from between the bed and frame.

⚠ CAUTION

To prevent damage to the vehicle while lifting the bed, continually check hoses, wires, brake lines, etc. to ensure everything is flexing properly and not binding. Ensure clearance between bed and cab is maintained.

3. Bed passenger side

- a. Using a hydraulic floor jack and a wood block, slowly lift passenger side of bed a little more than 3".
- b. Install a *kit block* (3" x 2") on each bed mount.

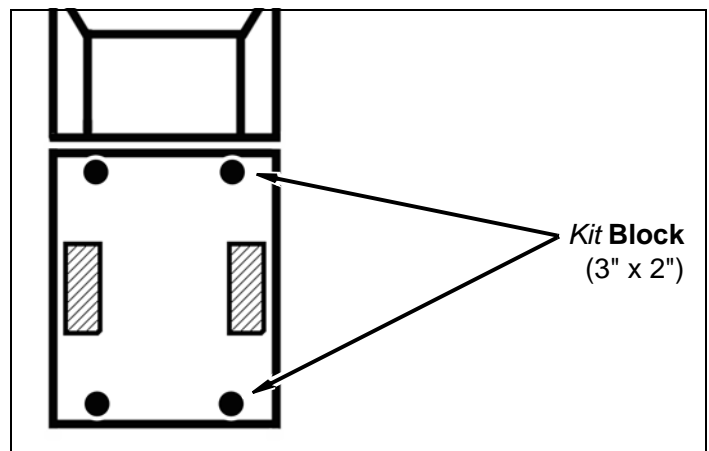

- c. Lower bed onto *kit blocks*.
- d. Install *kit bolts* (10mm x 120mm) and factory washers onto each bed mount. **DO NOT TIGHTEN.**

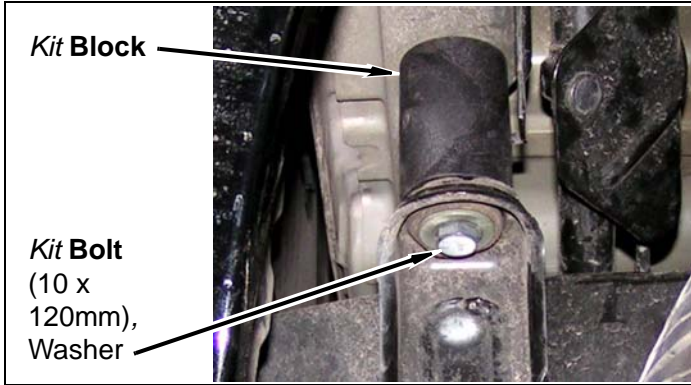

- e. Repeat previous steps on driver side of bed.
- f. Set bed-to-cab spacing according to previous measurement.
- g. Remove each *kit bolt*, one at a time, and apply a small amount of *kit Loctite®* onto threads. Install *kit bolt* and washer. **TIGHTEN *kit bolt* to 55 ft. lbs.**

Rear of Vehicle

1. Spare tire
 - a. Lower and remove spare tire according to vehicle owner's manual.
 - b. Remove two clips and winch tunnel from bed.
 - c. Remove two clips and winch horn from cross-member.

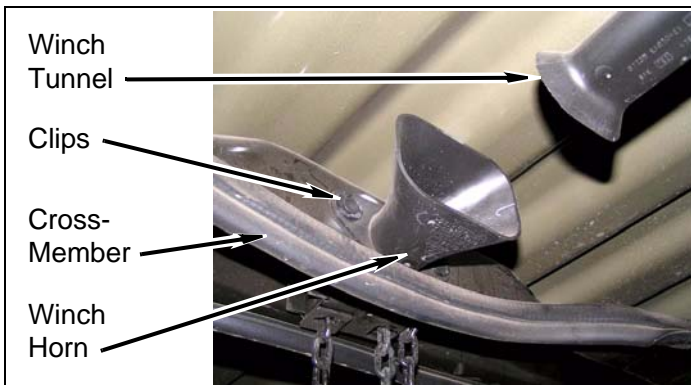

2. Rear bumper

⚠ WARNING

The following procedure is intended only to enhance the appearance of the vehicle. The rear bumper will no longer be rated for towing of any kind. Towing with the rear bumper after it has been lifted can result in death, serious personal injury, or damage to the vehicle. Towing after the bumper has been lifted should be accomplished using a rated Class III receiver type hitch.

- a. Mark and cut two bumper brackets from bumper crossmember as shown below.

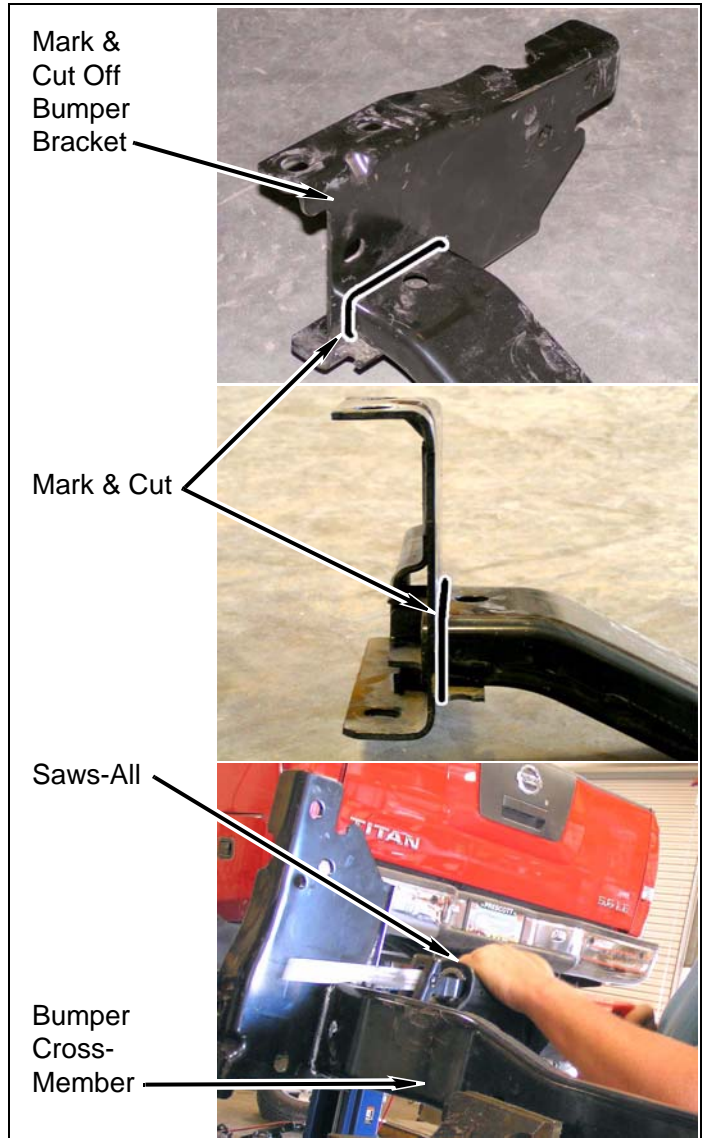

- b. Install cut bumper crossmember into two *kit brackets* (rear bumper).

- c. Install two **kit brackets** (rear bumper) onto frame rails with six bolts. Align bumper crossmember in two **kit brackets** (rear bumper). Snug bolts, but **DO NOT TIGHTEN**.

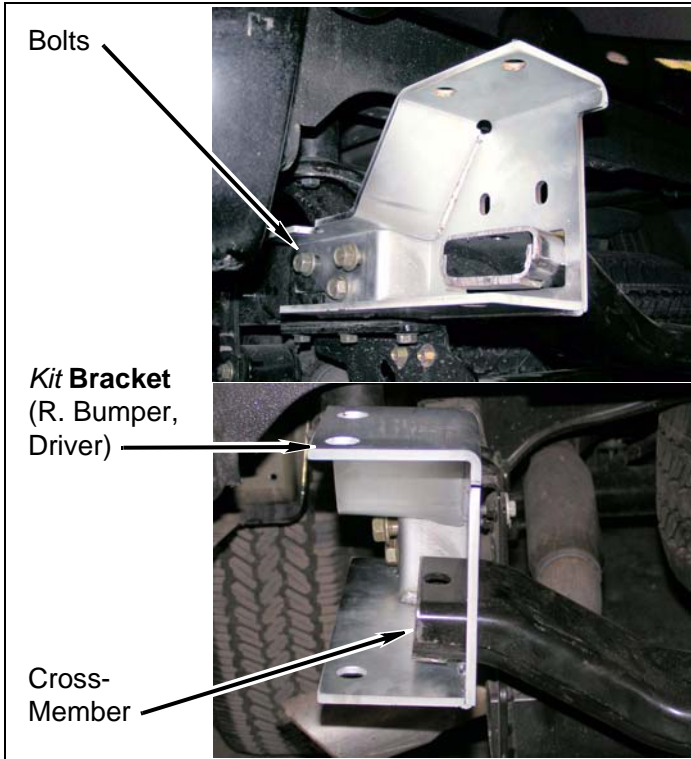

- d. Install two **kit brackets** (rear bumper, support) onto two **kit brackets** (rear bumper) with four **kit bolts** (1/2" x 1-1/2"), eight **kit washers** (1/2" USS), and four **kit nuts** (1/2" Nylock). Snug, but **DO NOT TIGHTEN**.

- e. Through center of four holes in two **kit brackets** (rear bumper, support), mark bumper crossmember.

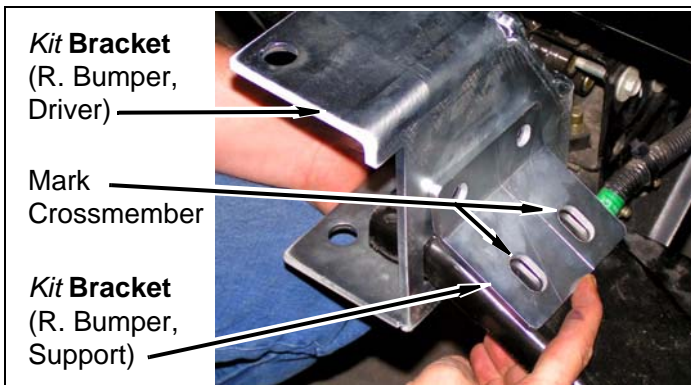

- f. Drill four 1/2" holes into bumper crossmember corresponding to previously made marks.

- g. Install two **kit brackets** (rear bumper, support) onto bumper crossmember with four **kit bolts** (1/2" x 1-1/2"), eight **kit washers** (1/2" USS), and four **kit nuts** (1/2" Nylock). **DO NOT TIGHTEN**.

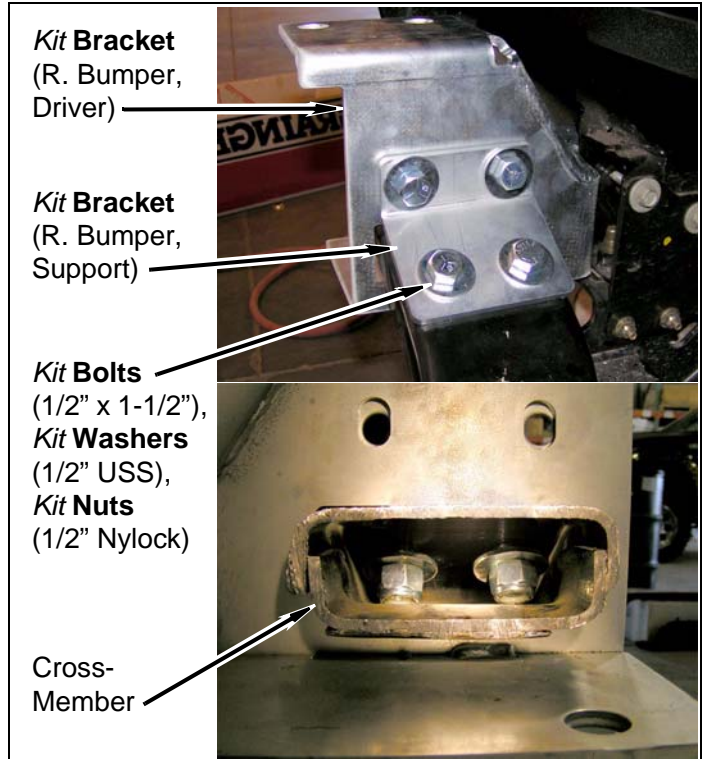

- h. Install bumper onto two **kit brackets** (rear bumper) with six studs and six nuts.

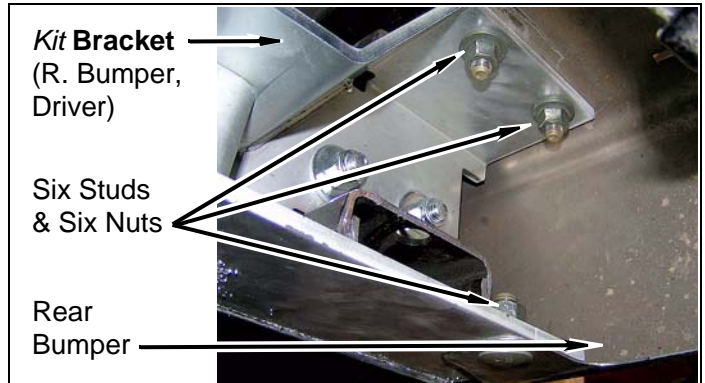

- i. Align bumper to bed according to previously recorded bumper to bed measurements.

- j. Install lower plastic step onto bumper and bumper crossmember.

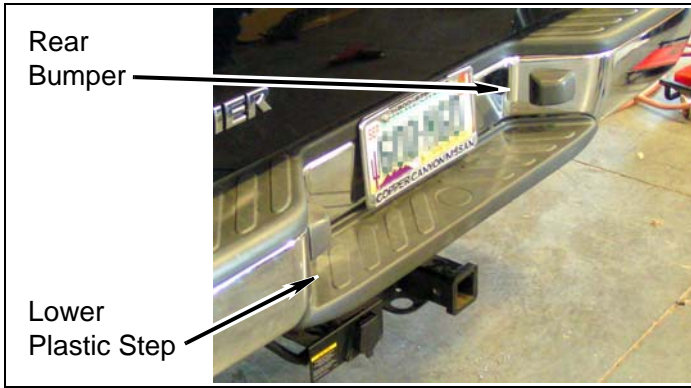

- k. TIGHTEN six studs and six nuts.
- l. TIGHTEN six bolts and two **kit brackets** (rear bumper).
- m. TIGHTEN eight **kit bolts** (1/2" x 1-1/2") and two **kit brackets** (rear bumper, support).
- n. Install upper plastic step onto bumper.

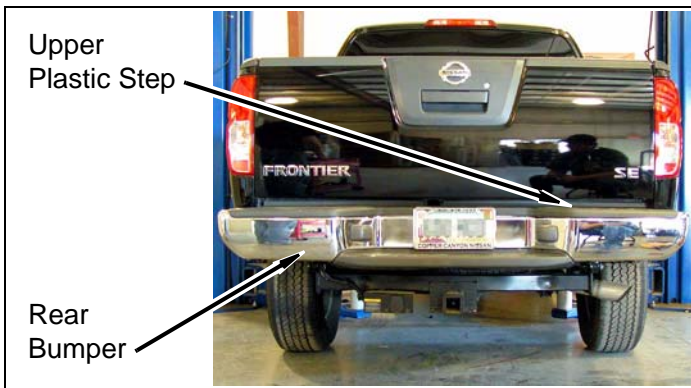

- o. Connect two license plate wiring harnesses onto rear bumper.

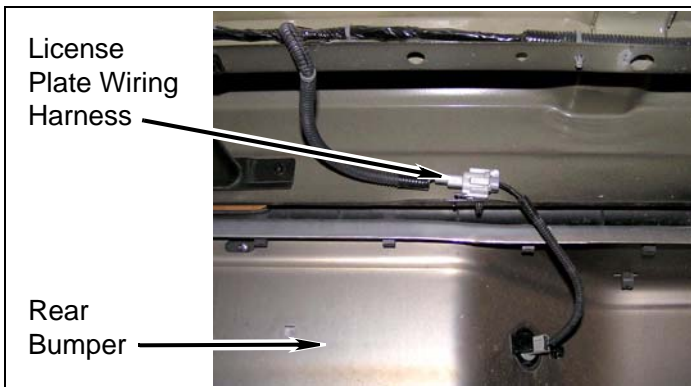

- p. Install spare tire onto vehicle.

3. Fuel filler

⚠ WARNING

Use extreme caution when working near the fuel lines and the fuel tank. Clean up spilled fuel immediately. A spark could cause an explosion or fire resulting in serious personal injury and property damage.

- a. Loosen clamp and remove fuel filler hose from fuel filler.

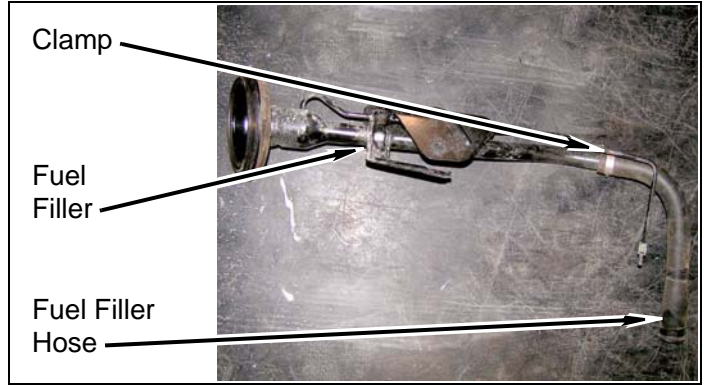

- b. Install **kit hose** (1" x 3") onto fuel filler with **kit clamp** (#20 hose). DO NOT TIGHTEN.

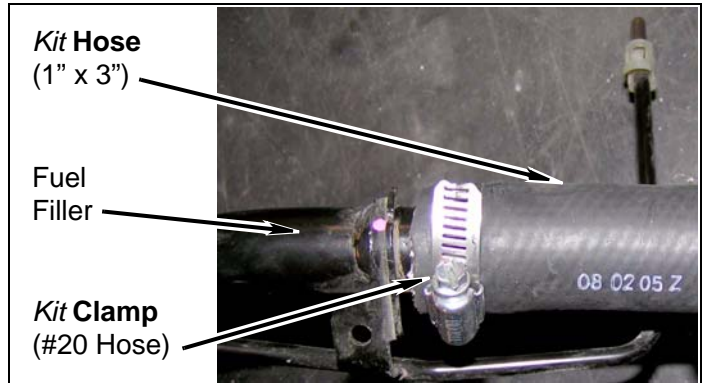

- c. Install **kit extension** (fuel filler) into **kit hose** (1" x 3") with **kit clamp** (#20 hose). DO NOT TIGHTEN.

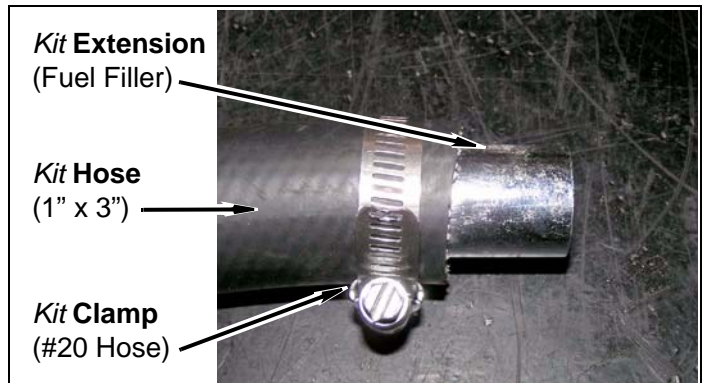

- d. Install fuel filler hose onto *kit extension* (fuel filler) with clamp. DO NOT TIGHTEN.

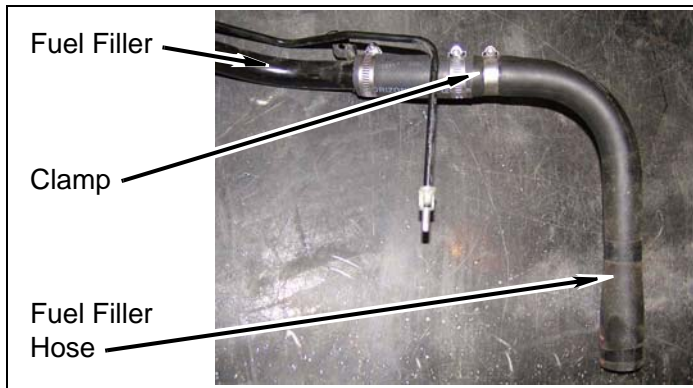

- e. Align top of fuel filler with bed side and install fuel filler hose onto fuel tank with clamp.
- f. Install vent hose and clip onto fuel filler vent tube.
- g. Adjust fuel filler hose and *kit hose* (1" x 3") and install fuel filler onto bed with bolt.

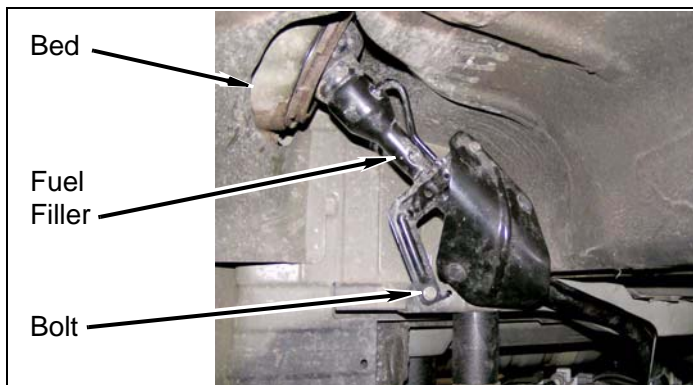

- h. TIGHTEN *kit clamps* (#20 hose) and clamps.
- i. Install fuel cap.

Underside of Vehicle

1. Parking brake cables

- a. Install two *kit brackets* (2-1/2" c-shaped) onto bottom center of cab with two nuts.
- b. Install two parking brake cables onto two *kit brackets* (2-1/2" c-shaped) with two *kit bolts* (1/4" x 1"), four *kit washers* (1/4" SAE), and two *kit nuts* (1/4" Nylock).

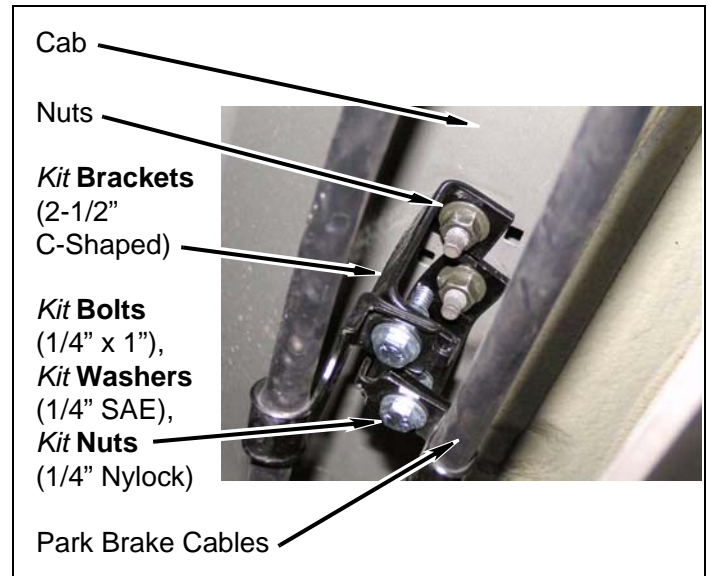

2. Crush blocks

⚠ WARNING

Welding should be performed by a certified welder or welding shop. Improper welding can damage vehicle and/or *kit* parts and cause serious personal injury.

- a. Remove four rubber pads from two frame rails.

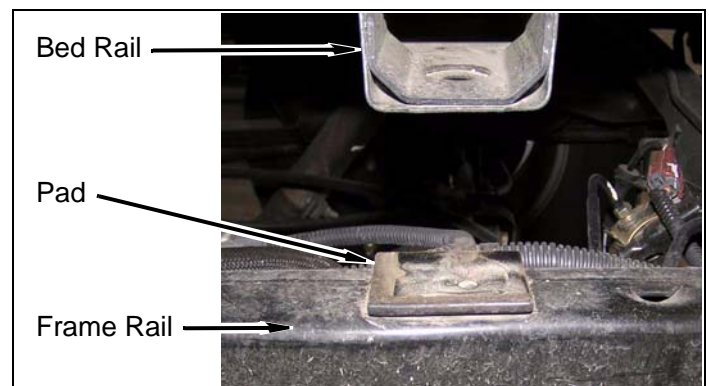

- b. Install rubber pad on top of each *kit spacer* (2" x 3" x 2").

- c. Install four **kit spacers** (2" x 3" x 2") between frame rail and bed rail and weld **kit spacers** (2" x 3" x 2") onto frame.

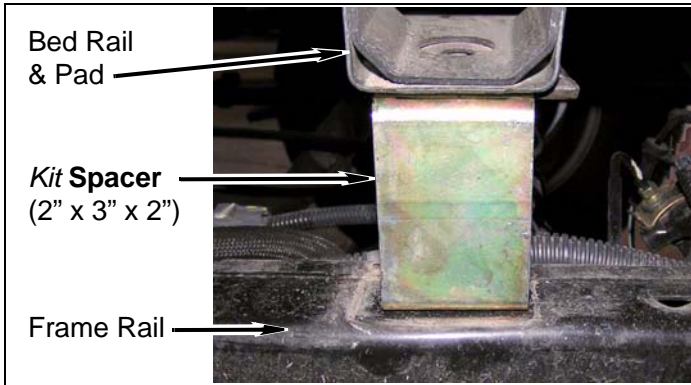

3. Exhaust ground strap

- a. Install **kit bracket** (3" w/ stud) onto exhaust with nut.
- b. Install ground strap onto **kit bracket** (3" w/ stud) with **kit washer** (1/4" SAE) and **kit nut** (1/4" Nylock).

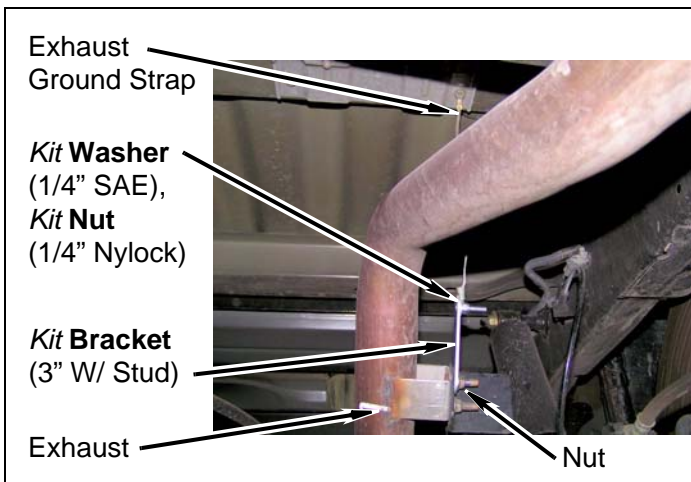

4. Wire harness

- a. Install **kit bracket** (3" w/ stud) onto passenger frame rail with bolt.
- b. Install bracket and wiring harness onto **kit bracket** (3" w/ stud) with **kit washer** (1/4" SAE) and **kit nut** (1/4" Nylock).

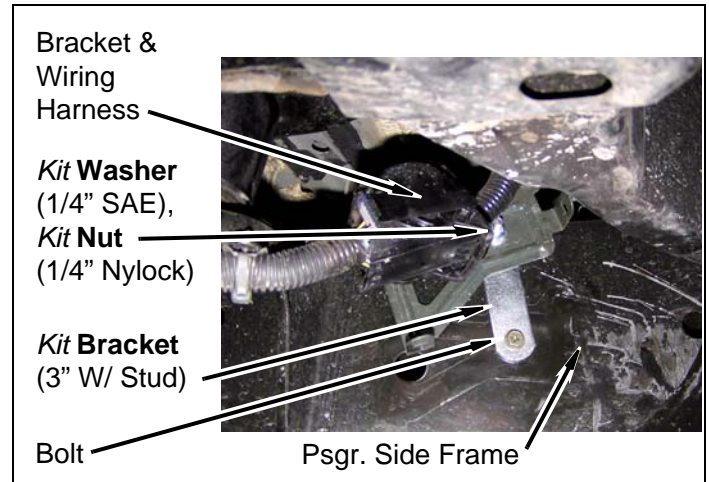

- c. Install plastic cover onto bracket.

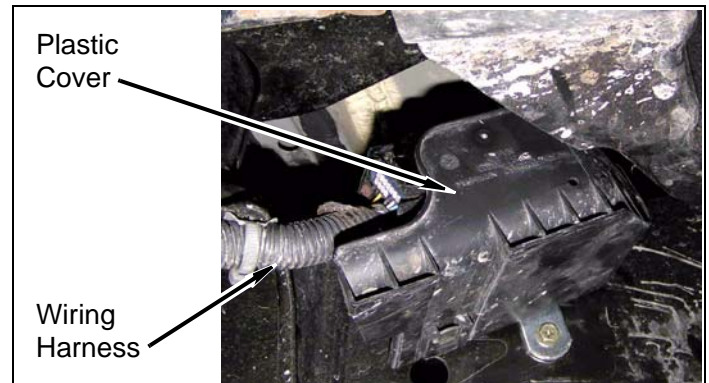

Inside of Vehicle

1. Manual transmission

- a. Mark cut and alignment marks along shift lever just below bend.

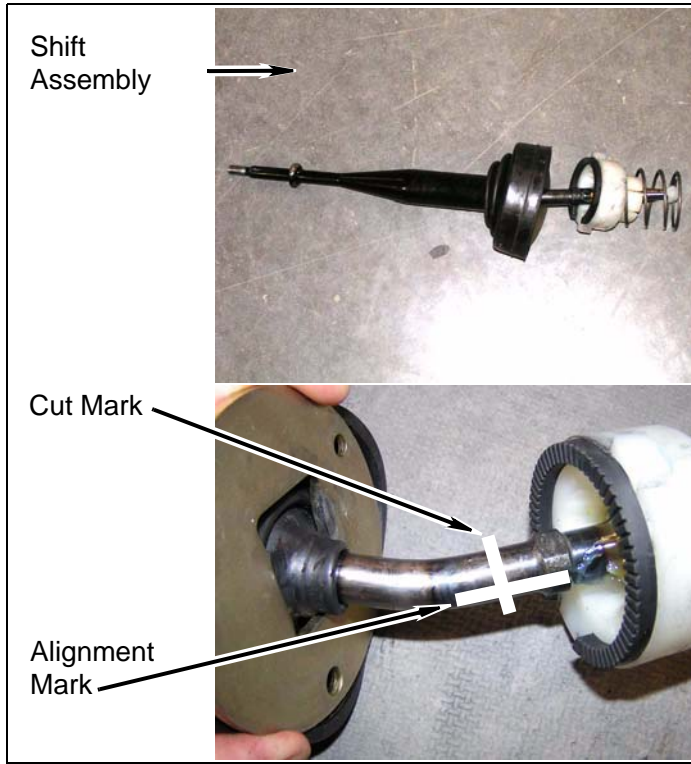

- b. Cut shift lever along cut mark.

⚠ CAUTION
Use wet rags to insulate plastic shift assembly components from welding heat. Damage may occur to shift lever assembly and/or components if care is not taken to protect components from heat while welding.

⚠ WARNING
Welding should be performed by a certified welder or welding shop. Improper welding can damage vehicle and/or *kit* parts and cause serious personal injury.

- c. Position *kit extension* (shift, 5/8" x 3") between two cut halves of shift lever and align previously made alignment marks. Weld *kit extension* into place.

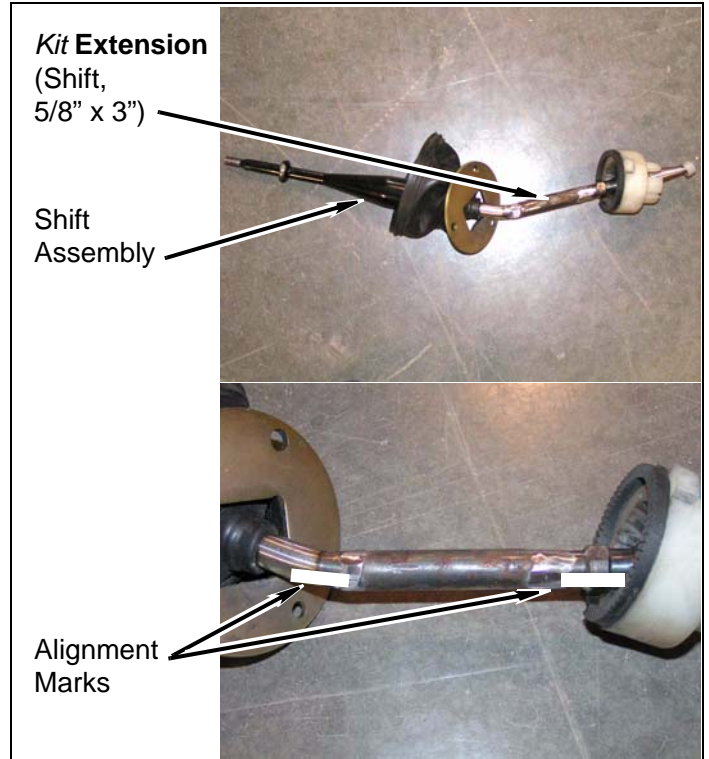

- d. Grind welds smooth and install shift lever assembly onto shift tower with three bolts.

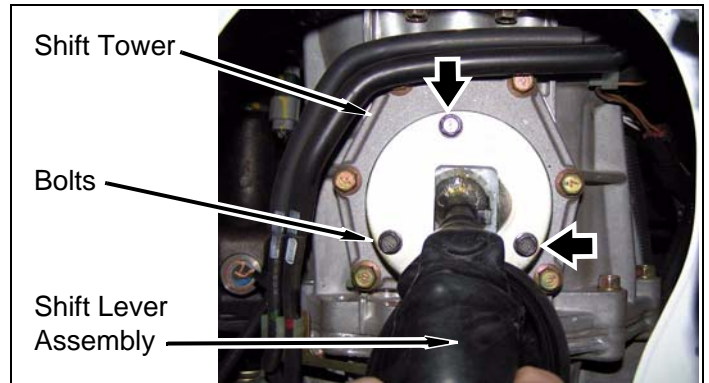

- e. Install shift tower boot onto shift tower using kit ties (zip).

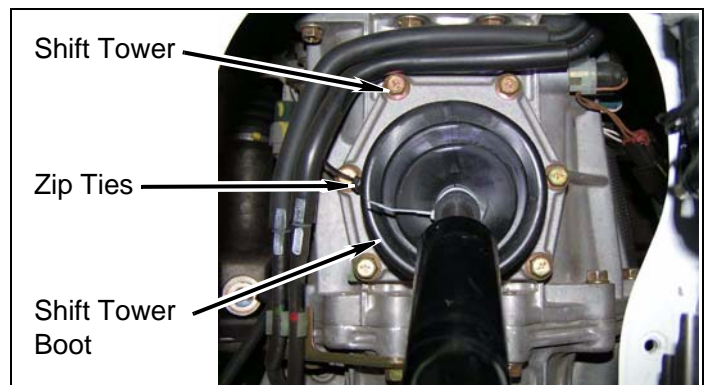

- f. Install two inner shift boots onto shift lever and floor with boot ring and four bolts.

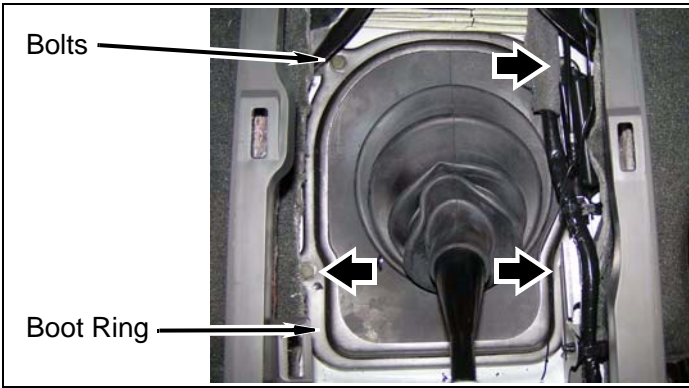

- g. Install wiring harness and bracket onto floor with bolt.

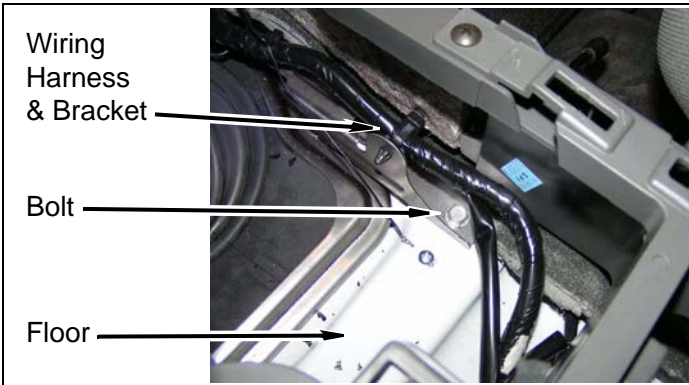

- h. Install shift boot trim panel onto center console.

- i. Install cup holder trim panel onto center console.

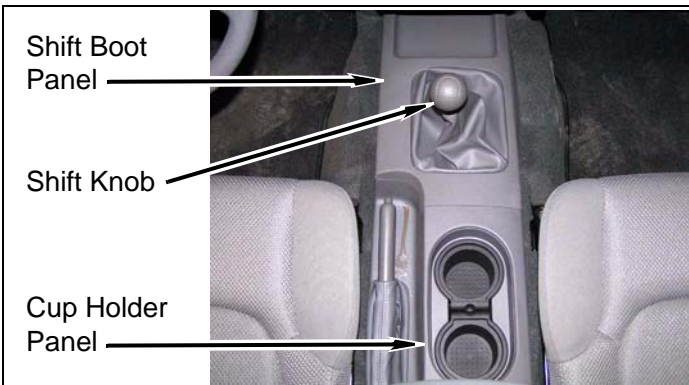

- j. Install shift knob onto shift lever.

Engine Compartment

- 1. Install heater core tube onto firewall with two nuts.

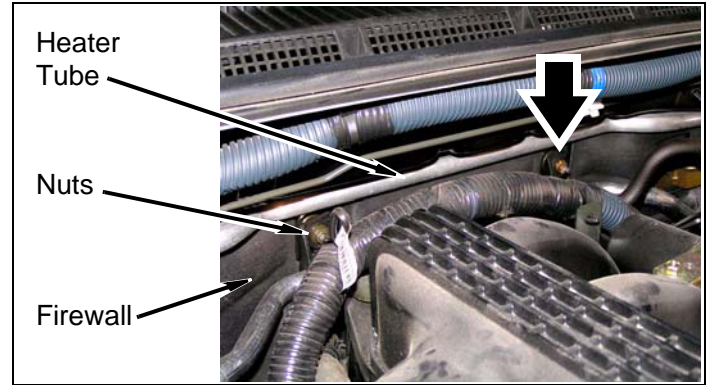

- 2. Install AC line and bracket onto driver side firewall with two bolts.

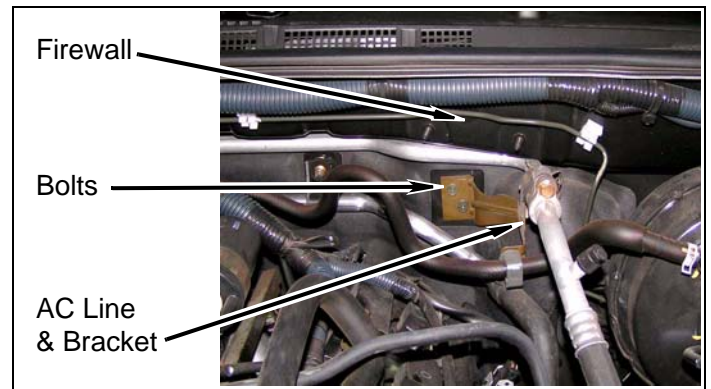

- 3. Brake line bracket

- a. Install *kit bracket* (2" w/ stud) onto lower hole of lower driver side firewall with bolt.

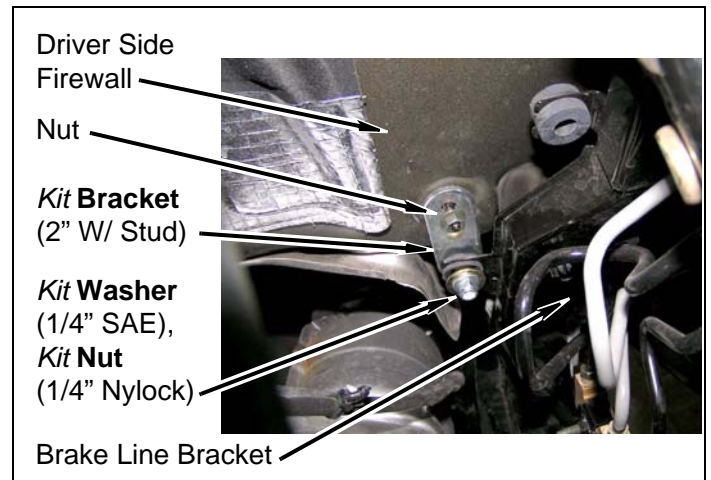

- b. Install *kit bracket* (2" step w/ stud) onto upper hole of lower driver side firewall with bolt.

- c. Install brake line bracket onto two **kit brackets** with two **kit washers** (1/4" SAE) and two **kit nuts** (1/4" Nylock).

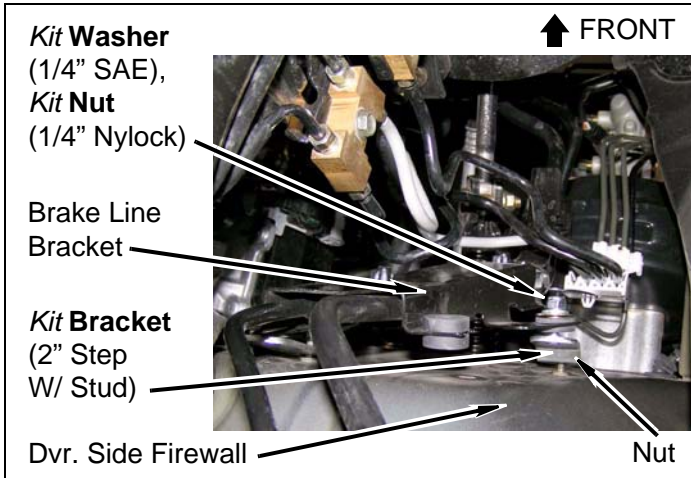

4. ABS sensors

- a. Install **kit bracket** (2" w/ stud) onto driver side spring perch with bolt.
- b. Install ABS harness and bracket onto **kit bracket** (2" w/ stud) with **kit washer** (1/4" SAE) and **kit nut** (1/4" Nylock).

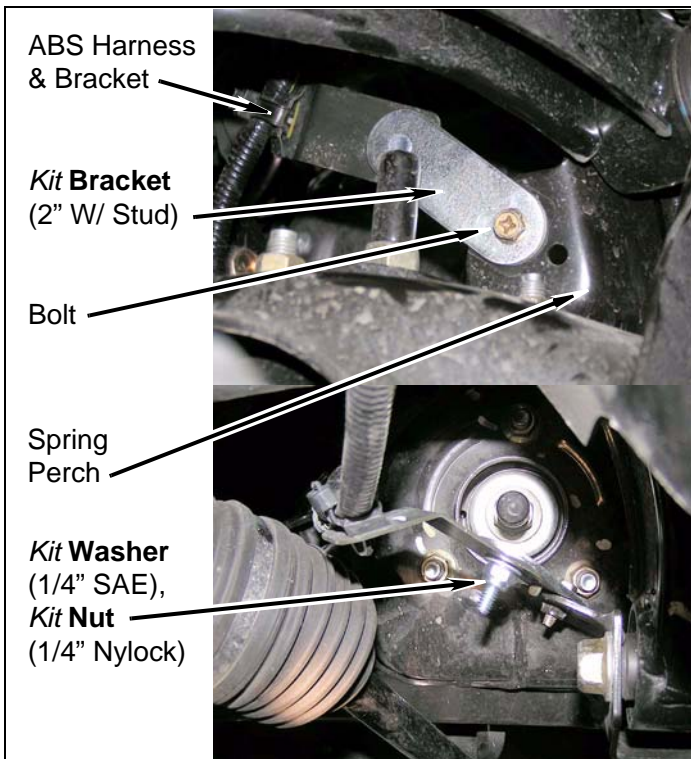

- c. Repeat above steps for passenger side ABS harness and bracket.

5. Steering shaft

⚠ WARNING

Verify the steering extension is securely installed as specified in the instructions. Failure to do so may cause steering malfunction, resulting in property damage or serious personal injury.

- a. Install **kit extension** (steering) into lower steering shaft. Ensure marks on lower steering shaft and rack & pinion are aligned.
- b. Install rack & pinion into **kit extension** (steering), ensuring marks on lower steering shaft and rack & pinion are aligned.

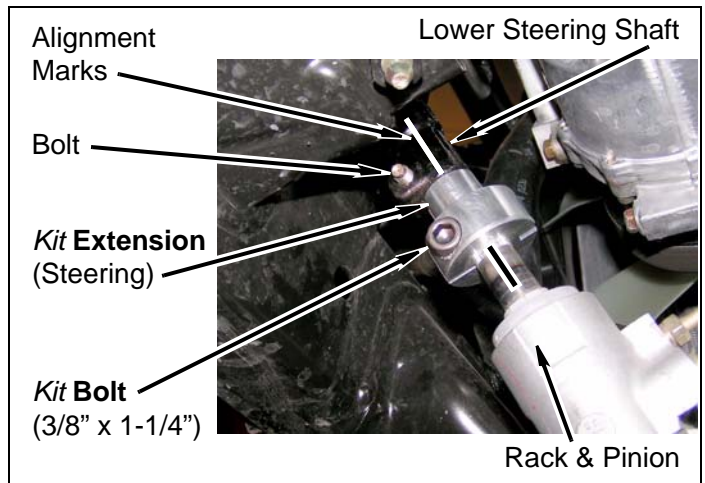

- c. Apply a small amount of **kit Loctite®** onto factory bolt and **kit bolt** (3/8" x 1-1/4").
- d. Install and **TIGHTEN** bolts to **33 lb.-ft.**

- 6. Install engine wiring harness onto engine and wheel well with two clips.

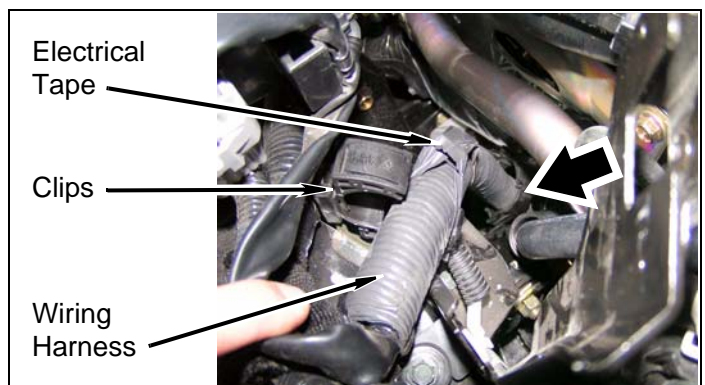

7. Power steering reservoir

- a. Remove cap and drain contents of reservoir into clean drain pan or bucket.
- b. Position drain pan or bucket beneath large diameter hose on passenger side of engine.

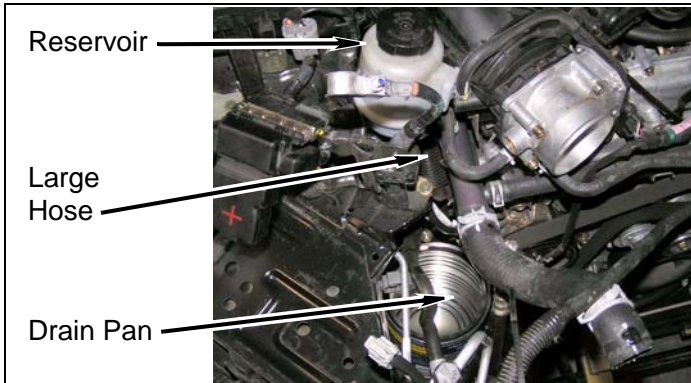

- c. Remove clamp and large diameter hose from engine and drain contents into drain pan or bucket.

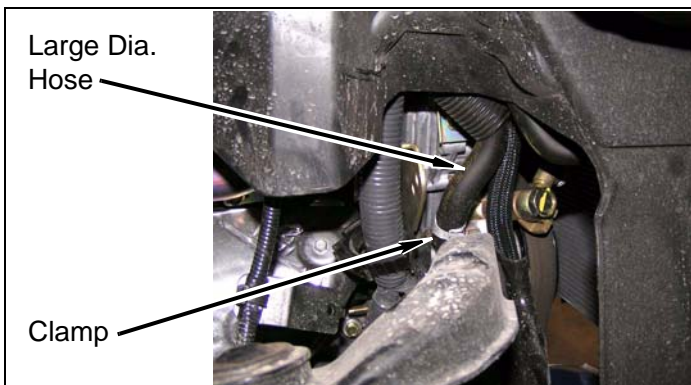

- d. Remove clamp and large diameter hose from reservoir.

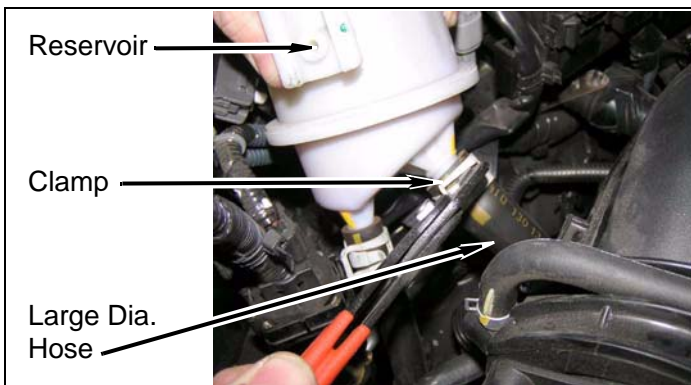

- e. Remove two factory hose clamps and heat shield from hose.

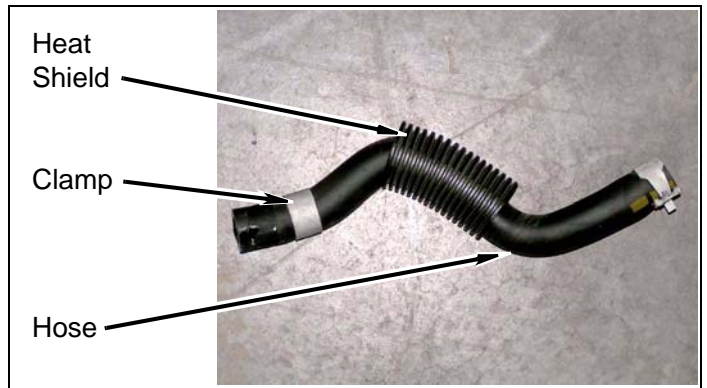

- f. Install heat shield and two factory clamps onto *kit hose* (5/8" x 14").

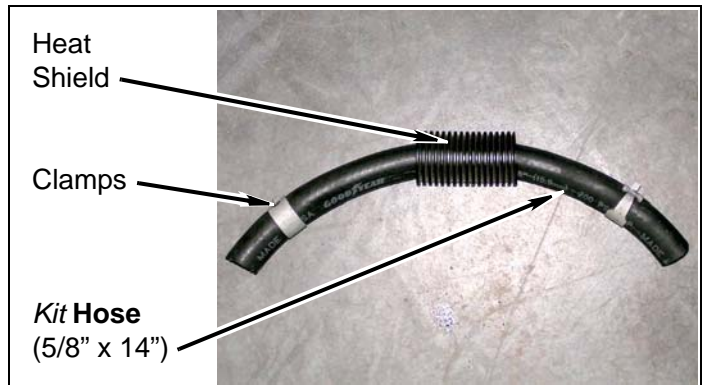

NOTE

This kit is supplied with two **kit clamps** (#10 hose) if the two factory clamps (above) do not fit over **kit hose** (5/8" x 14").

- g. Install **kit hose** (5/8" x 14") onto engine and reservoir with two factory clamps.

- h. Install bracket onto passenger side wheel well with three bolts.

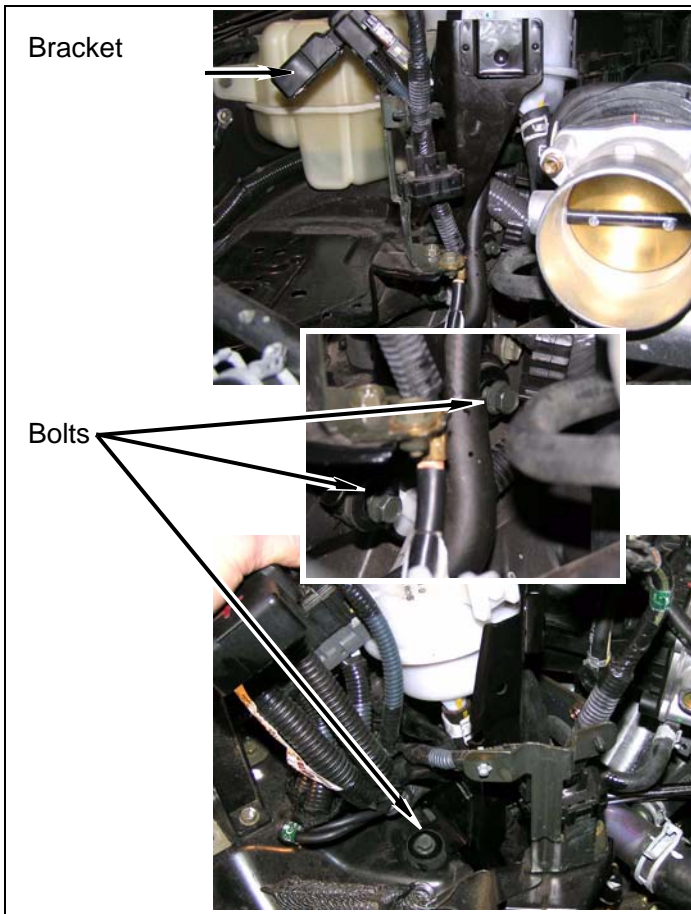

- i. Install reservoir onto bracket.

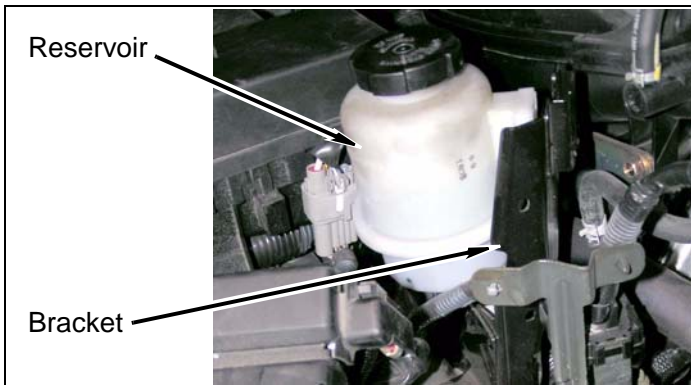

⚠ CAUTION

Reuse power steering fluid ONLY if fluid is not contaminated. Follow vehicle owner's manual instructions for refilling power steering fluid. Contaminated or improper fluid may cause damage and/or failure.

- j. Refill reservoir using power steering fluid from drain pan or bucket.

8. Radiator brackets

- a. Remove bolt and driver side bracket from radiator.

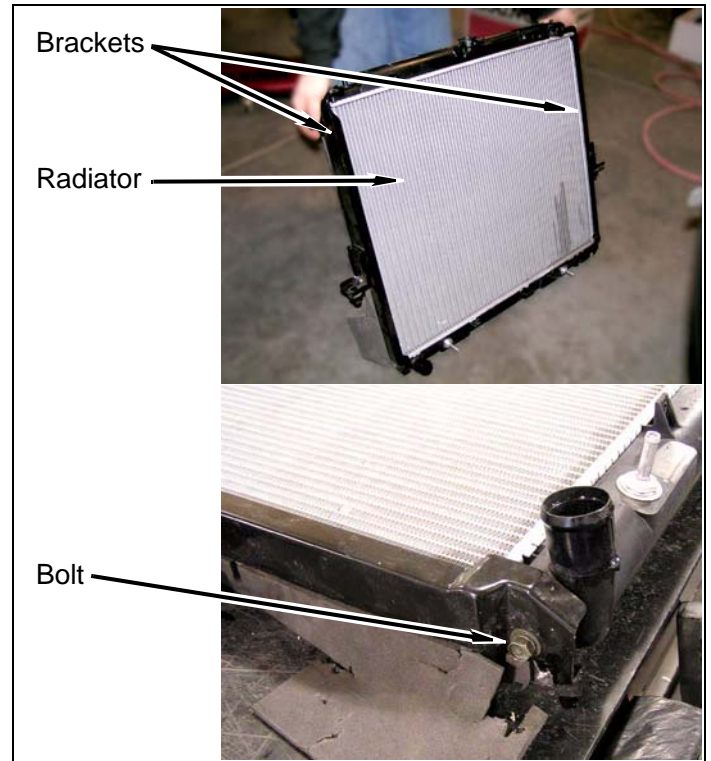

b. Mark and cut bracket as shown.

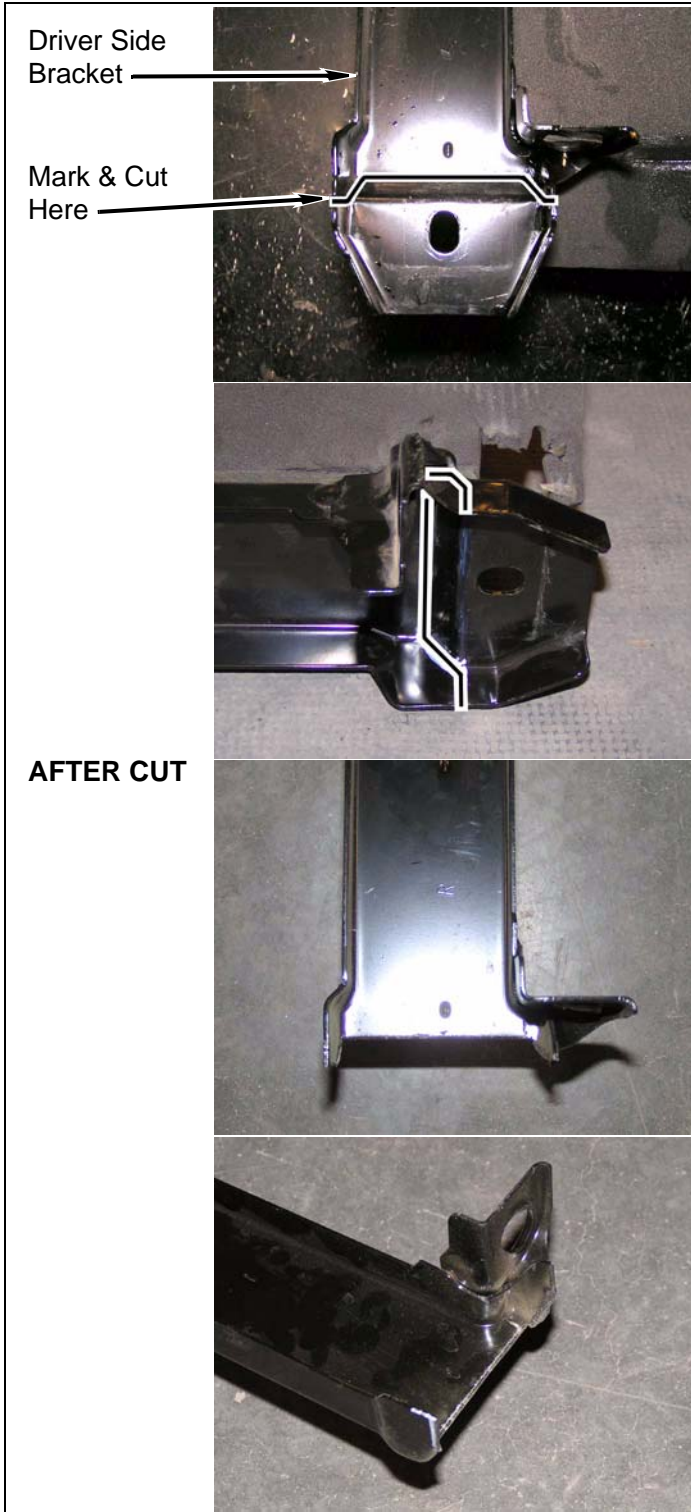

c. Position **kit bracket** (radiator, driver) onto bracket and mark bracket through two holes in **kit bracket**. Ensure **kit bracket** is set to 3".

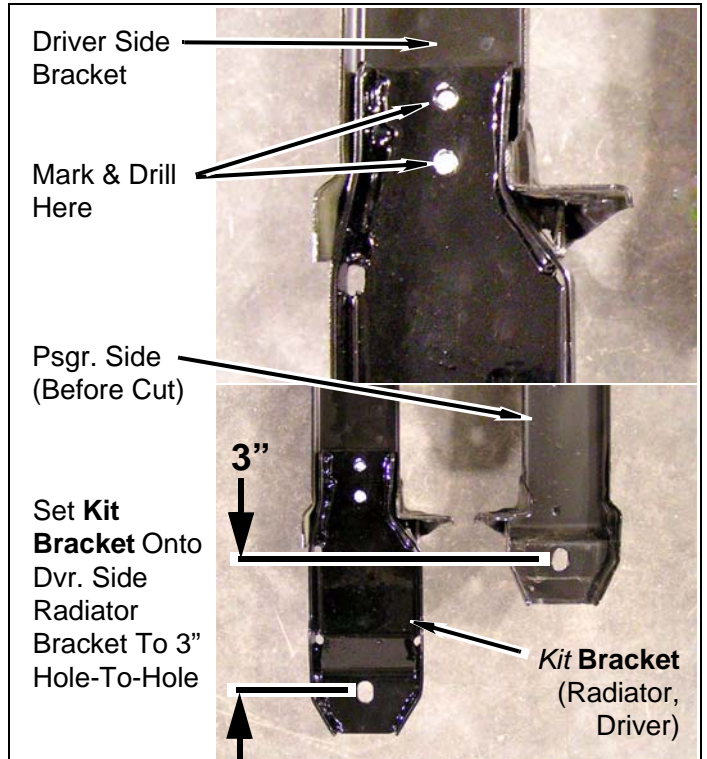

d. Drill two 1/4" holes into bracket corresponding to holes in **kit bracket** (radiator, driver).

e. Install **kit bracket** (radiator, driver) onto bracket with two **kit bolts** (1/4" x 1"), four **kit washers** (1/4" SAE), and two **kit nuts** (1/4" Nylock). Ensure **kit bolt** heads are facing out.

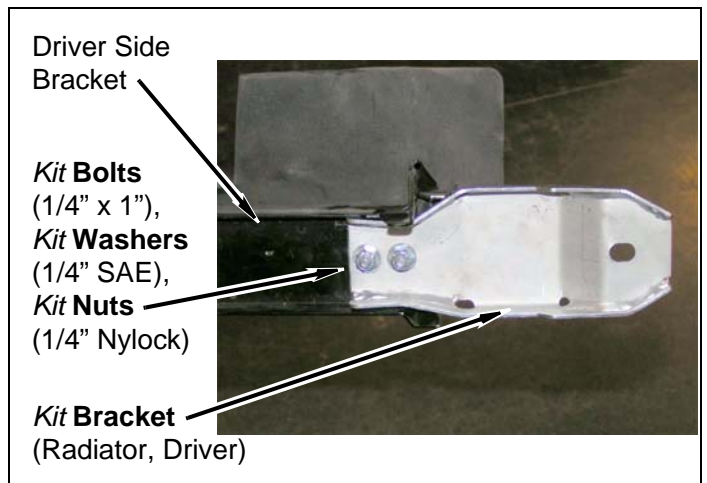

f. Remove rubber isolator from bracket and install onto large hole of **kit spacer** (2" x 3" x 1").

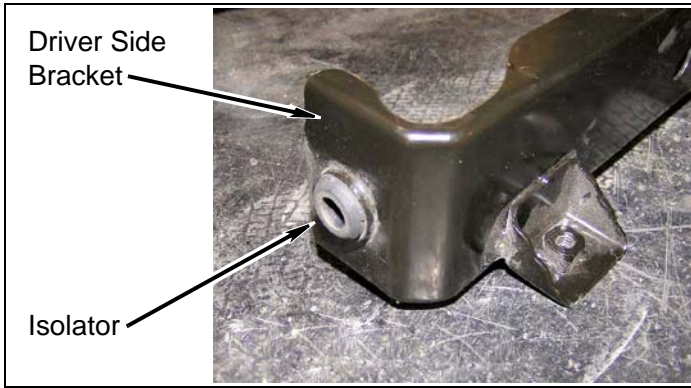

g. Install **kit spacer** (2" x 3" x 1") onto driver side radiator pin.

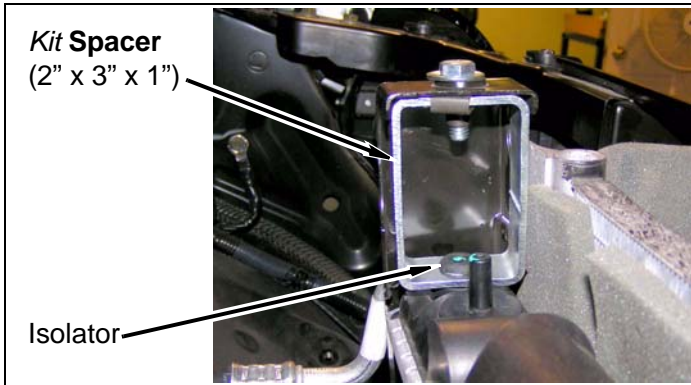

h. Install **kit u-nut** (5/16") onto **kit spacer** (2" x 3" x 1").

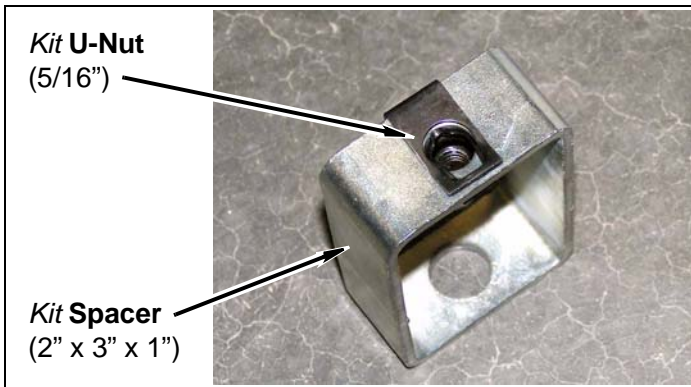

i. Mark and cut driver side bracket to clear radiator.

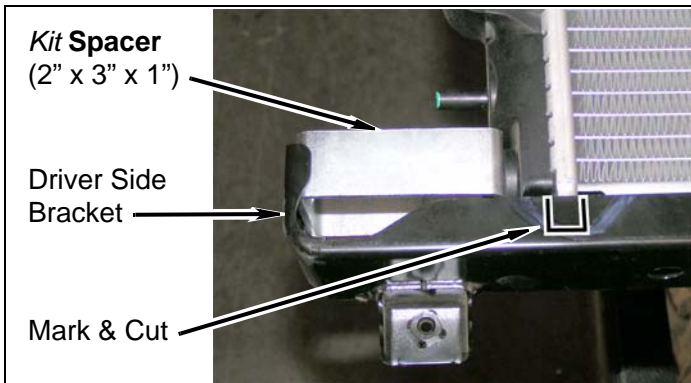

j. Install bracket onto lower driver side radiator with bolt. **DO NOT TIGHTEN.**

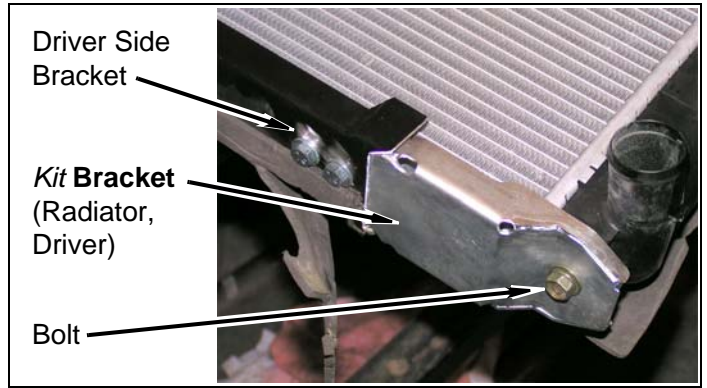

k. Install bracket onto **kit spacer** (2" x 3" x 1") with **kit washer** (5/16" USS) and **kit bolt** (5/16" x 1").

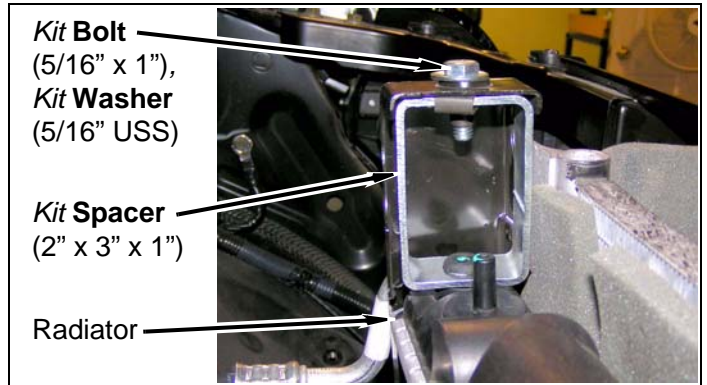

l. **TIGHTEN** lower bolt and **kit bolt** (5/16" x 1").

m. Repeat above steps for passenger side bracket.

9. Power steering cooler line

- a. Install **kit bracket** (2" Z-shaped) onto passenger side frame with bolt.
- b. Install power steering cooler line onto **kit bracket** (2" Z-shaped) with **kit bolt** (1/4" x 1"), two **kit washers** (1/4" SAE), and **kit nut** (1/4" Nylock).

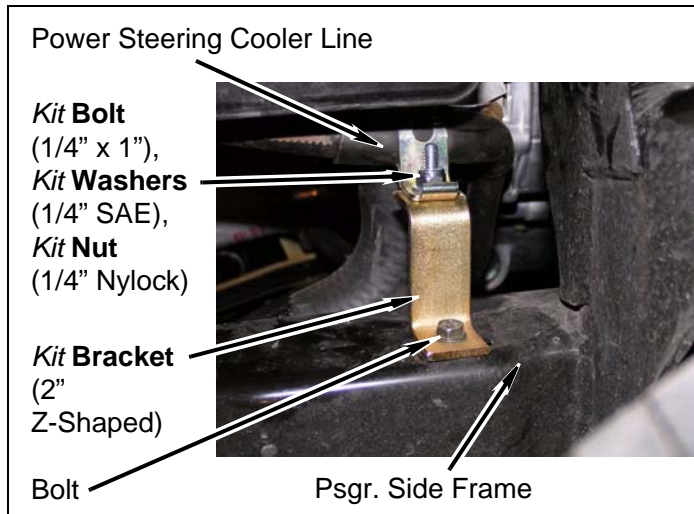

10. Fan shroud & radiator

- a. Install radiator onto core support brackets.
- b. Remove **kit ties** from core support and AC condenser.

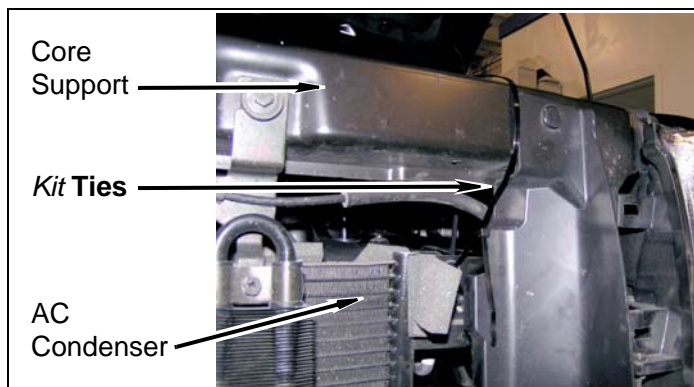

⚠ CAUTION

CAREFULLY bend AC line. Over bending AC line may cause the line to crack and/or leak.

- c. Slightly bend AC line down on AC condenser and install AC condenser onto radiator with two bolts.

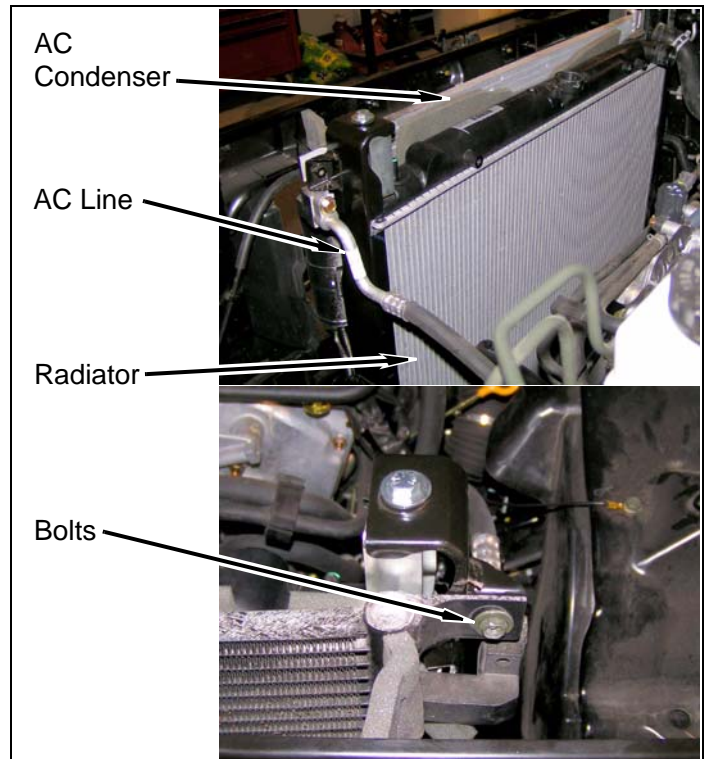

- d. Remove two rubber isolators from two radiator brackets and install onto large hole two **kit spacers** (2" x 3" x 1").

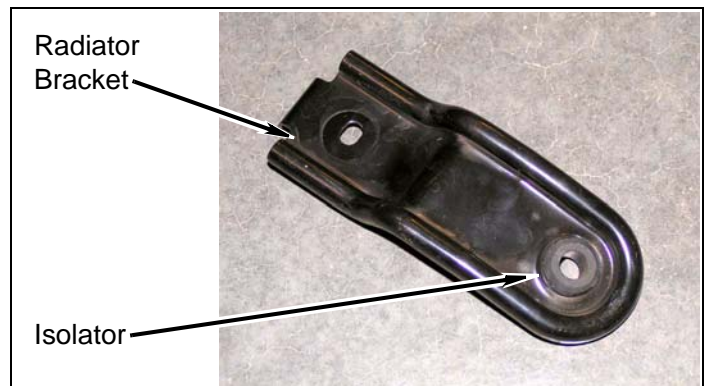

- e. Install two radiator brackets onto core support with two bolts.

f. Install two **kit u-nuts** (5/16") onto two **kit spacers** (2" x 3" x 1").

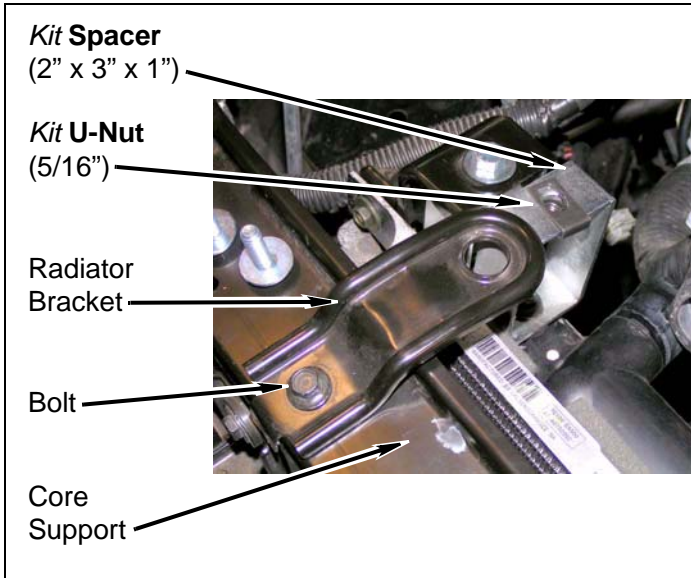

g. Install radiator onto radiator brackets with two **kit washers** (5/16" USS) and two **kit bolts** (5/16" x 1").

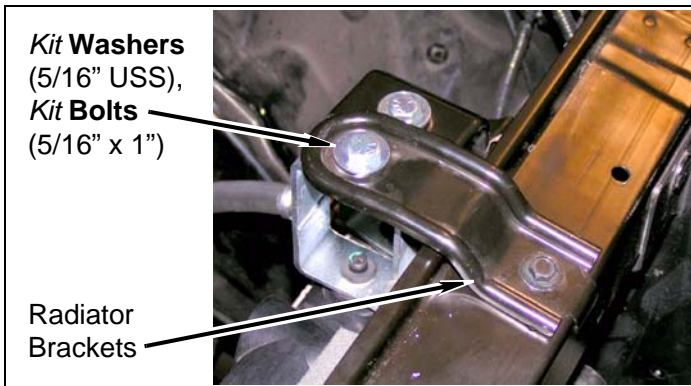

h. Install fan and fan clutch onto pulley with four nuts.

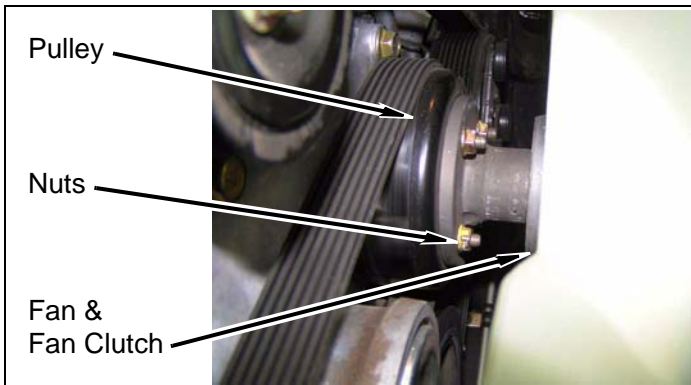

i. Install fan shroud and electric fan onto radiator with three bolts.

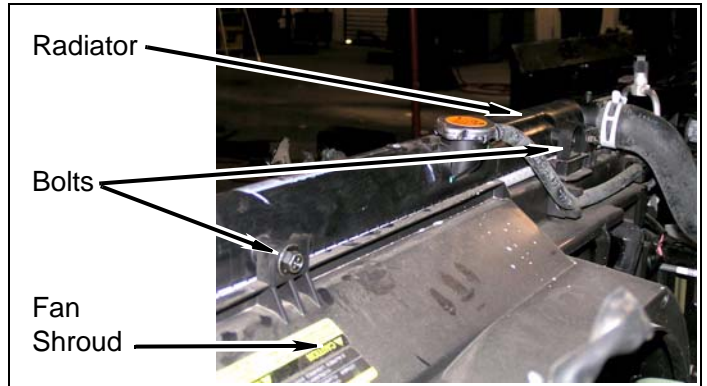

j. Connect AC condenser and electric fan wiring harnesses.

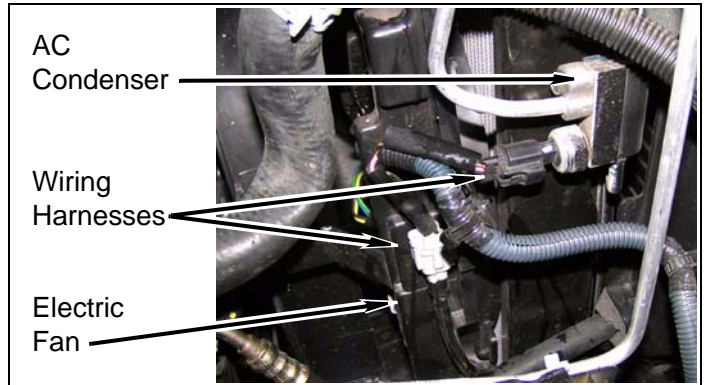

k. Install two transmission cooler lines onto radiator with two clamps, if equipped.

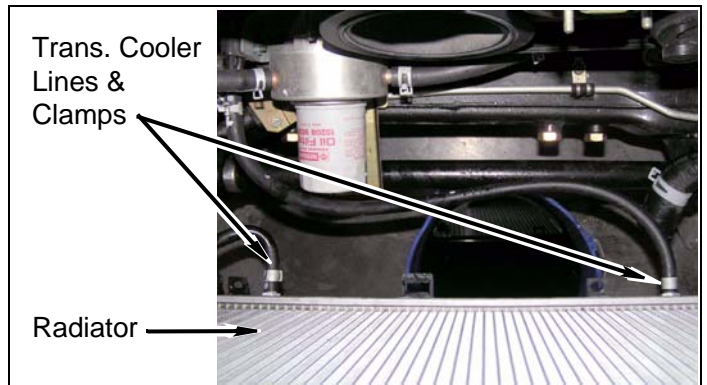

l. Install lower fan shroud onto fan shroud with two clips.

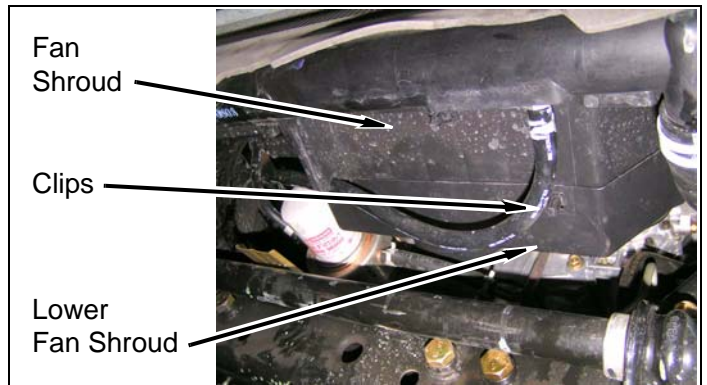

- m. Install upper and lower radiator hoses with two clamps.

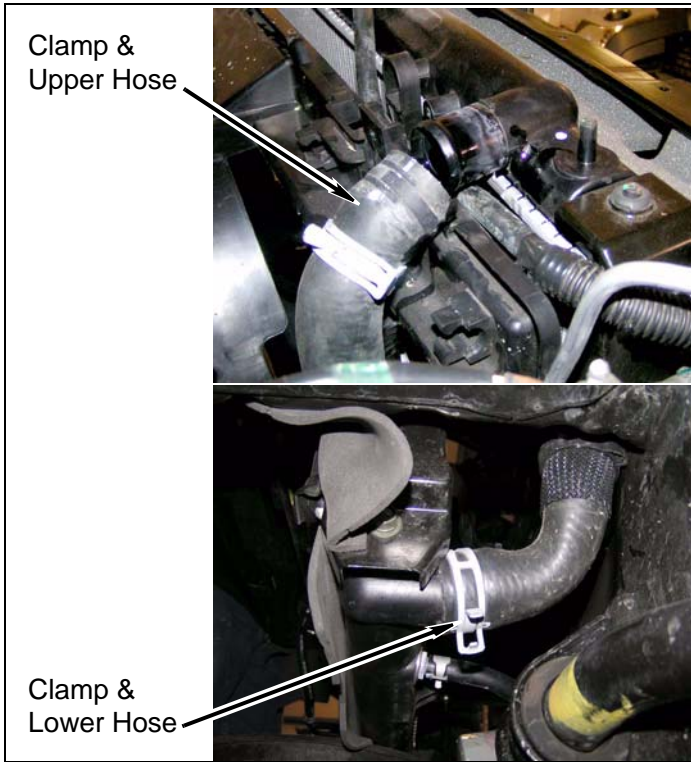

- n. Install overflow hose onto radiator with clamp.

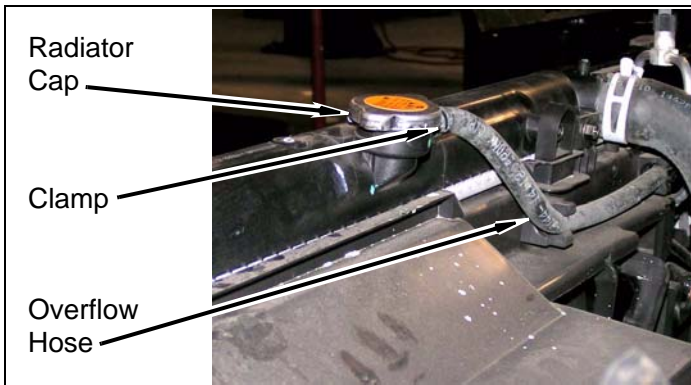

- o. Clip hoses onto fan shroud, if necessary.

⚠ CAUTION
 Reuse coolant ONLY if coolant is not contaminated. Follow vehicle owner's manual instructions for refilling coolant. Contaminated or improper coolant may cause damage and/or failure.

- p. Refill radiator using coolant from drain pan or bucket.
- q. Install radiator cap.

11. Airbox

- a. Install air filter into airbox.
- b. Install airbox cover onto airbox with two clips.
- c. Connect wiring harness onto airbox cover.

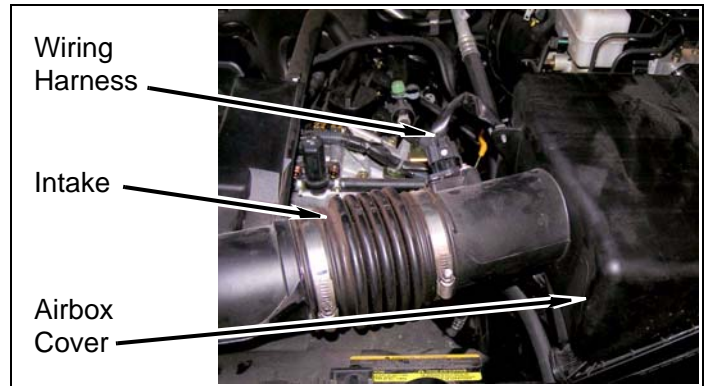

- d. Install intake onto throttle body and airbox cover with two clamps. DO NOT TIGHTEN clamps.

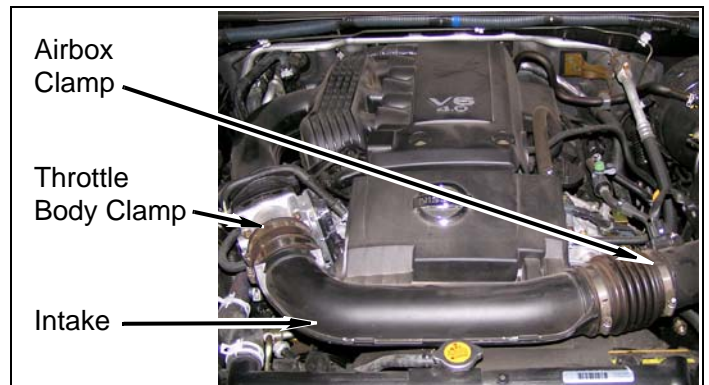

- e. Install intake chamber onto passenger side bracket with bolt. DO NOT TIGHTEN.

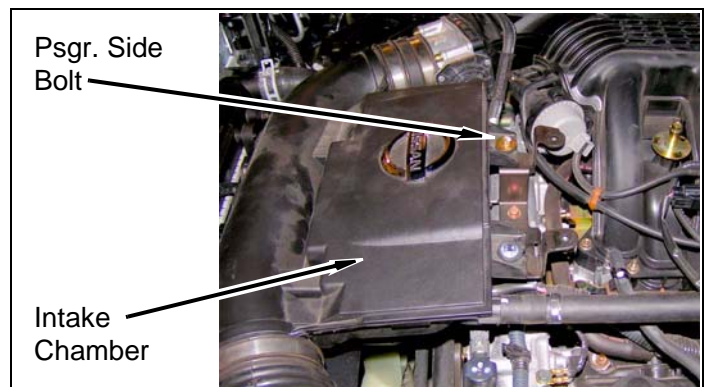

- f. Install *kit spacer* (.250") between intake chamber mount and driver side bracket.

- g. Install intake chamber onto driver side bracket with **kit washer** (1/4" SAE) and **kit bolt** (6mm x 30mm).

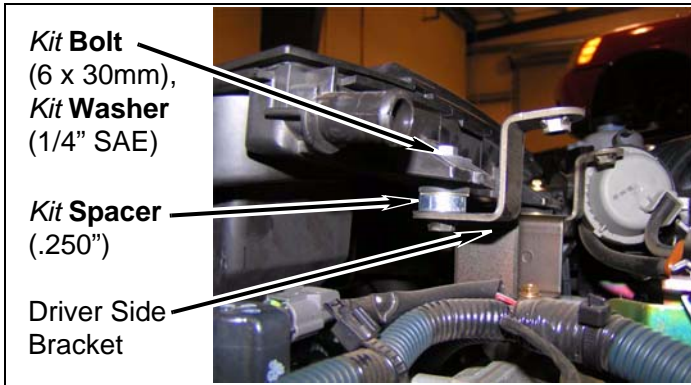

- h. TIGHTEN two clamps and intake chamber bolt.

- i. Install vent hose onto intake chamber with clamp.

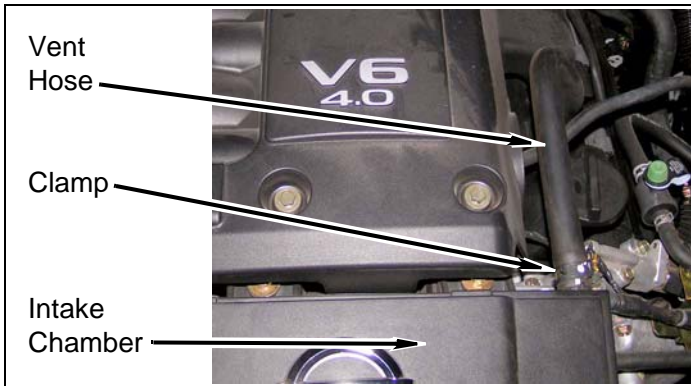

12. Install engine cover onto engine with two bolts.

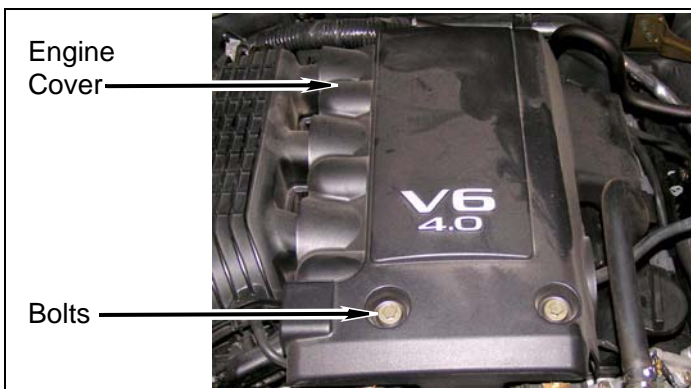

Front of Vehicle

1. Front bumper

- a. Apply a small amount of **kit Loctite®** (6ml bottle) onto threads of two bolts and install **kit bracket** (front bumper, driver) onto driver side frame rail with two bolts. DO NOT TIGHTEN.

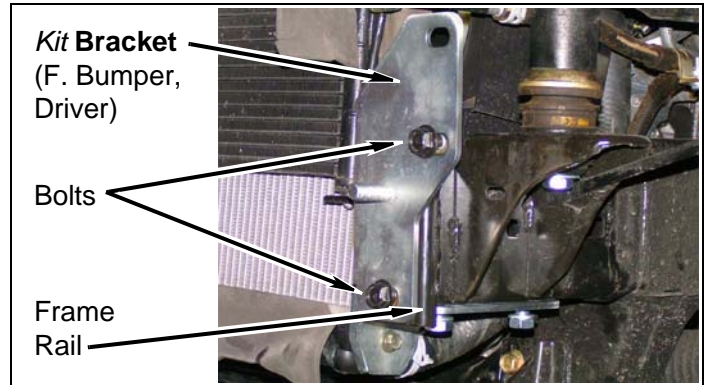

- b. Repeat above step for **kit bracket** (front bumper, passenger).

- c. Apply a small amount of **kit Loctite®** (6ml bottle) onto threads of two **kit bolts** (12mm x 30mm) and install **kit bracket** (front bumper, driver) onto bottom of frame rail with two **kit bolts** (12mm x 30mm) and two **kit washers** (12mm).

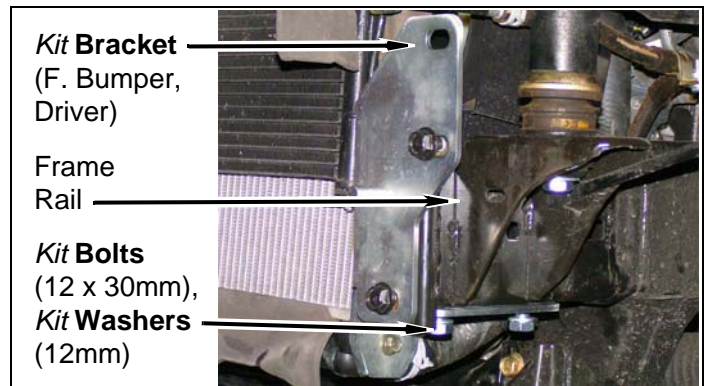

- d. Apply a small amount of **kit Loctite®** (6ml bottle) onto threads of two bolts and install tow hook and **kit bracket** (front bumper, passenger) onto bottom of frame rail with two bolts.

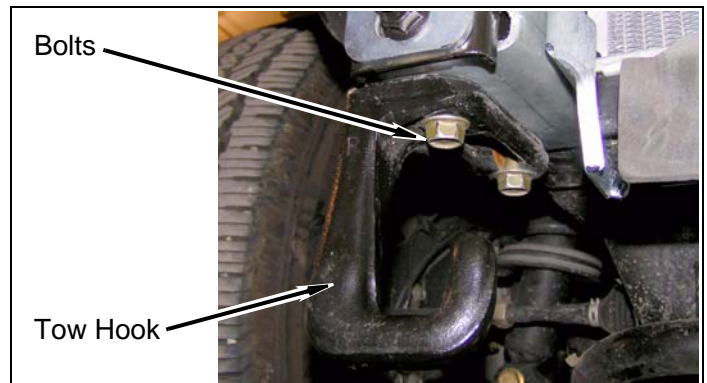

- e. TIGHTEN six factory bolts and two **kit bolts** (12mm x 30mm).
- f. Position lower mount holes of bumper support onto **kit bracket** (front bumper) studs and mark interference between top bolts and backside of bumper support.³

- h. Install bumper support onto two **kit bracket** (front bumper) studs with two **kit washers** (1/2" SAE) and two **kit nuts** (1/2" Nylock). DO NOT TIGHTEN.

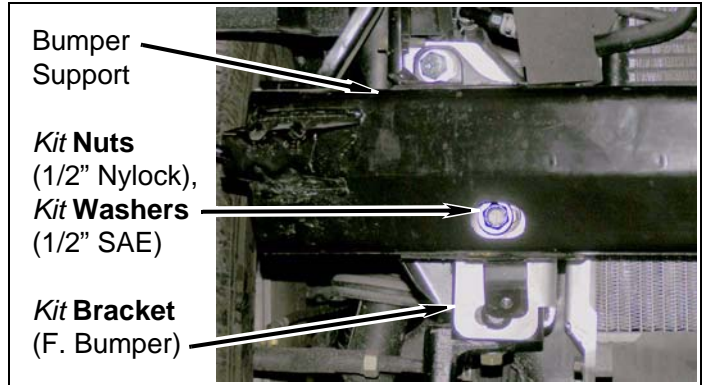
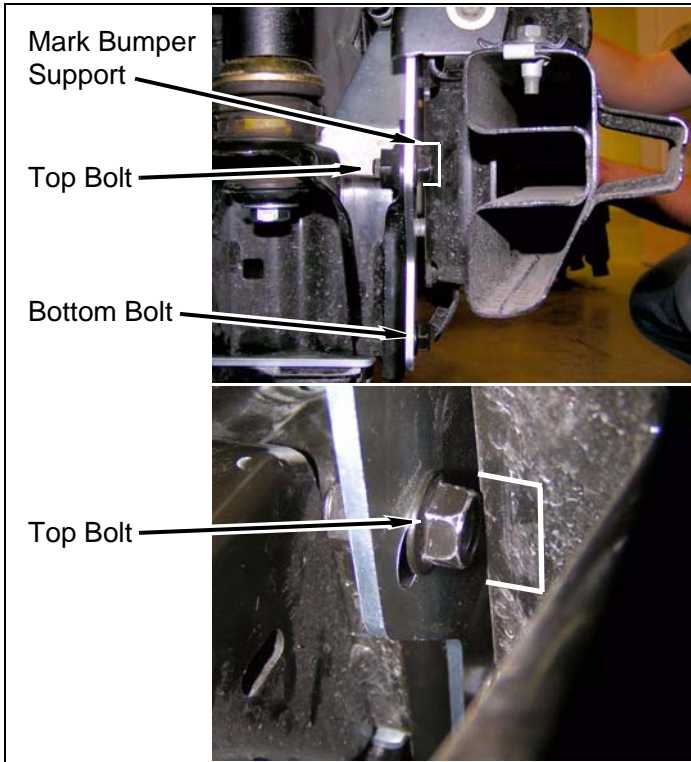

- i. Install bumper support onto two **kit brackets** (front bumper) with two **kit bolts** (1/2" x 1-1/2"), four **kit washers** (1/2" SAE), and two **kit nuts** (1/2" Nylock).

- g. Cut or drill two holes into bumper support corresponding to upper two bolts.

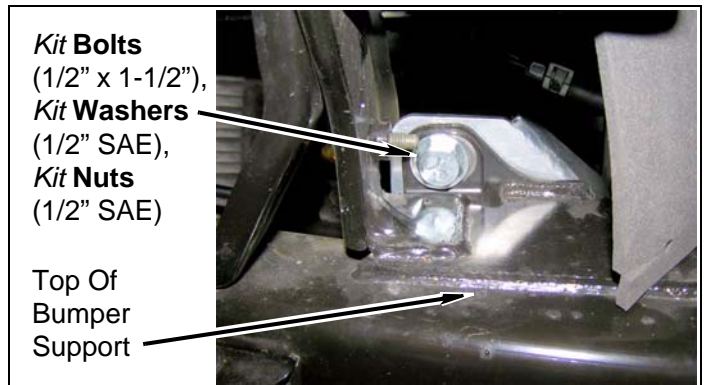

- j. TIGHTEN two **kit bolts** (1/2" x 1-1/2") and two **kit nuts** (1/2" Nylock) on two **kit bracket** (front bumper) studs.

- k. Install bumper onto upper bumper support with four bolts. DO NOT TIGHTEN.

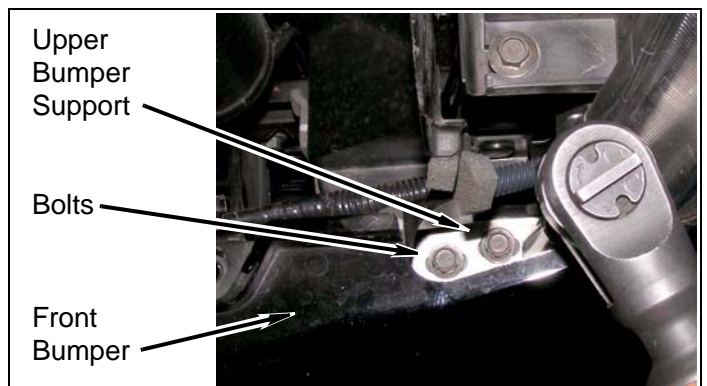
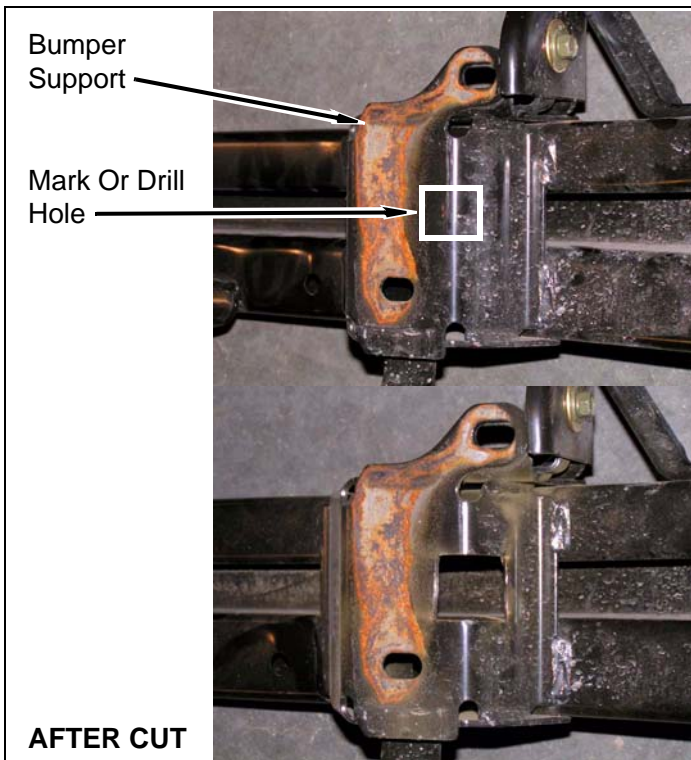

- l. Connect two fog light wiring harnesses, if equipped.

m. Bend lower bumper brackets to meet lower bumper support brackets.

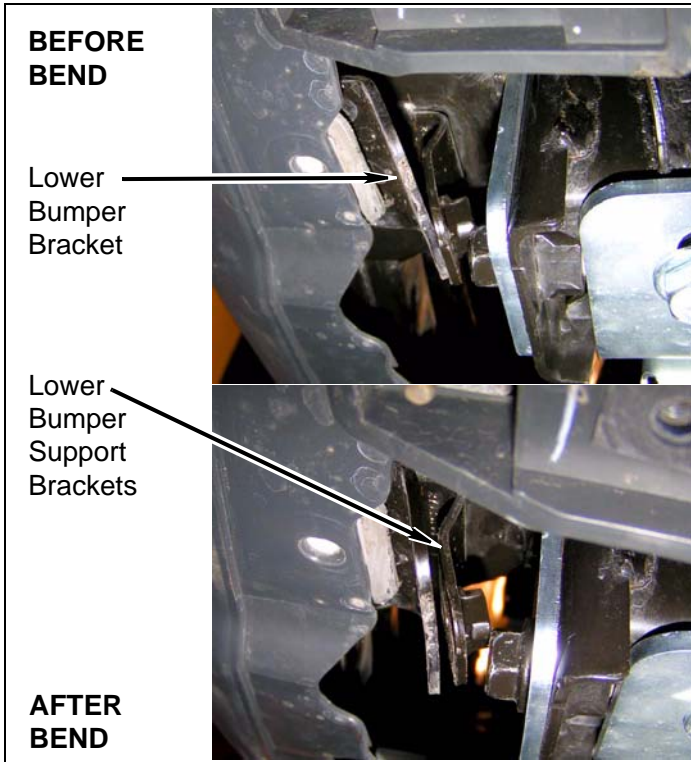

n. Install bumper onto lower bumper support brackets with two bolts.

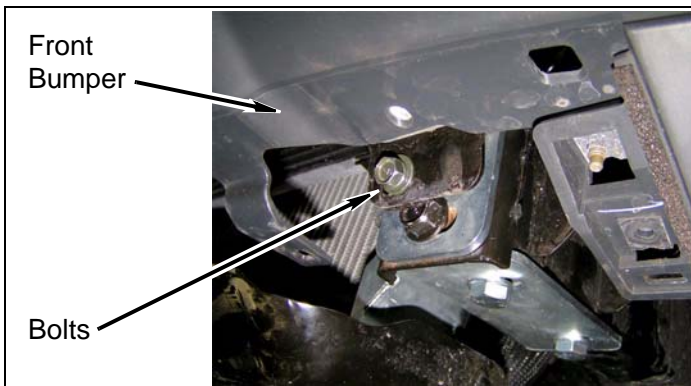

o. TIGHTEN six bumper bolts.

p. Install two bumper side supports onto driver and passenger side of bumper with two bolts.

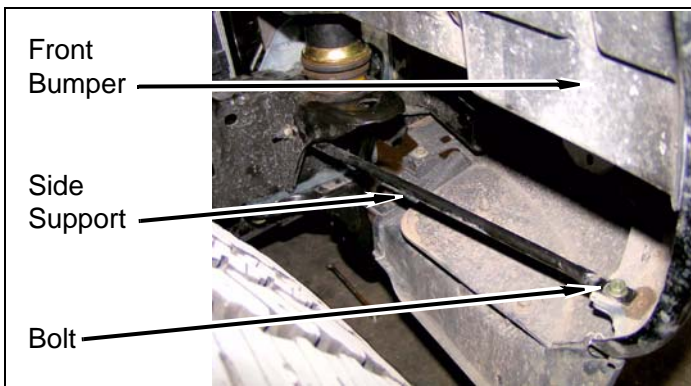

2. Grill

a. Install grill onto core support with four turn clips and four lower clips.

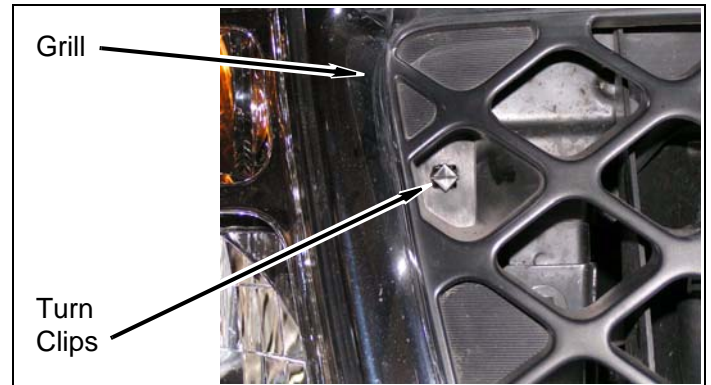

b. Install top of grill onto core support with six pop-up clips.

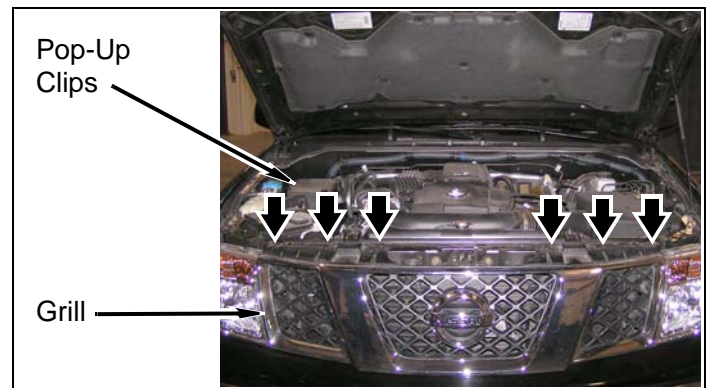

3. Skid plate

a. Mark and cut skid plate as shown.

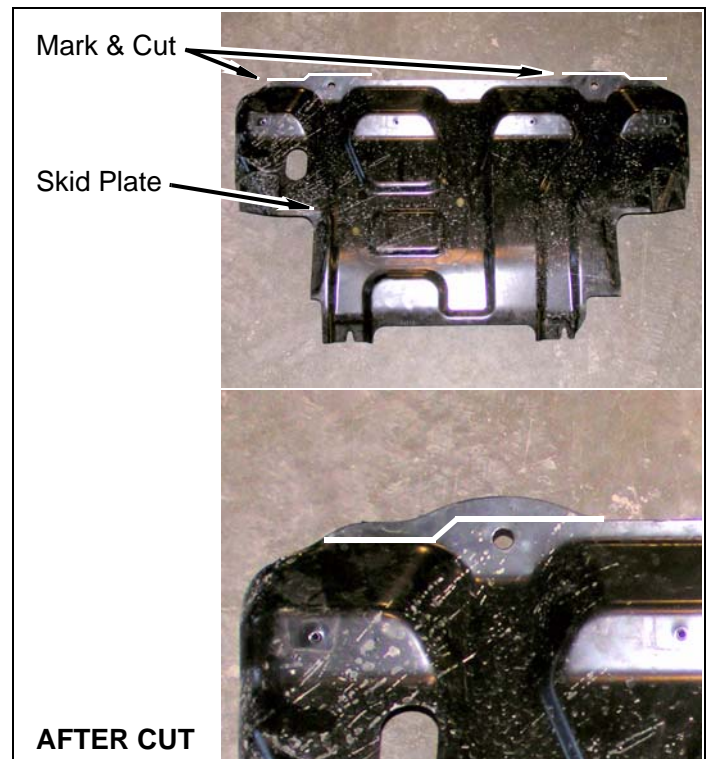

- b. Install *kit u-nut* (5/16") onto two *kit spacers* (2" x 3" x 1").

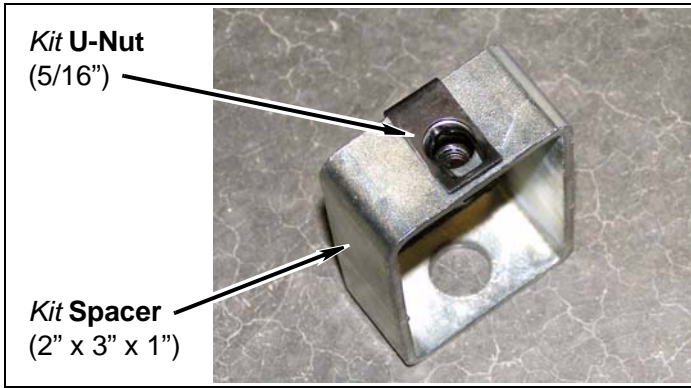

- c. Install two *kit spacers* (2" x 3" x 1") onto bumper support with two front skid plate bolts.

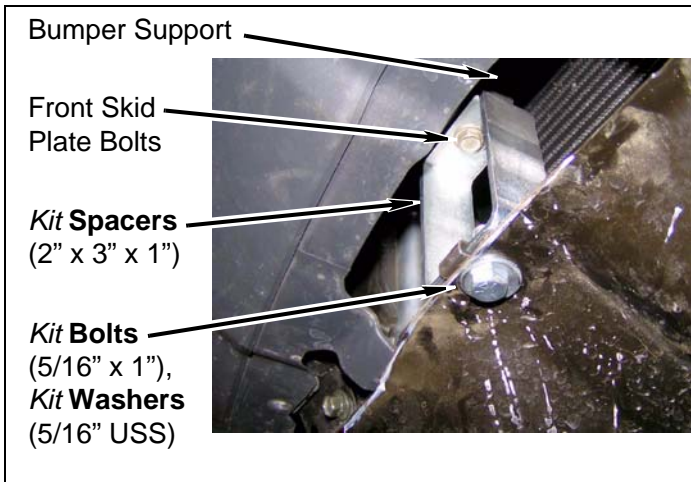

- d. Install skid plate onto crossmember with two rear skid plate bolts.

- e. Install skid plate onto two *kit spacers* (2" x 3" x 1") with two *kit washers* (5/16" USS) and two *kit bolts* (5/16" x 1").

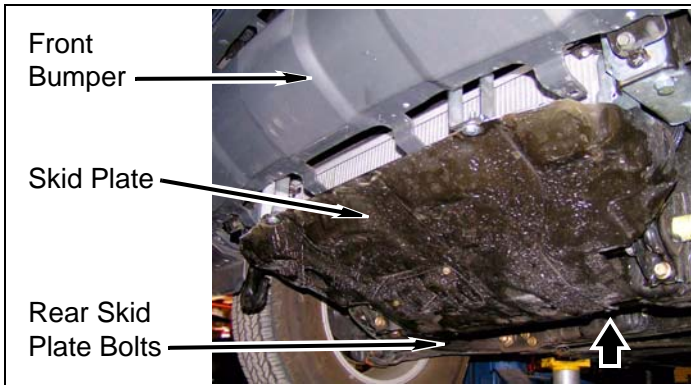

4. Lower fascia

- a. Mark and cut lower fascia as shown.

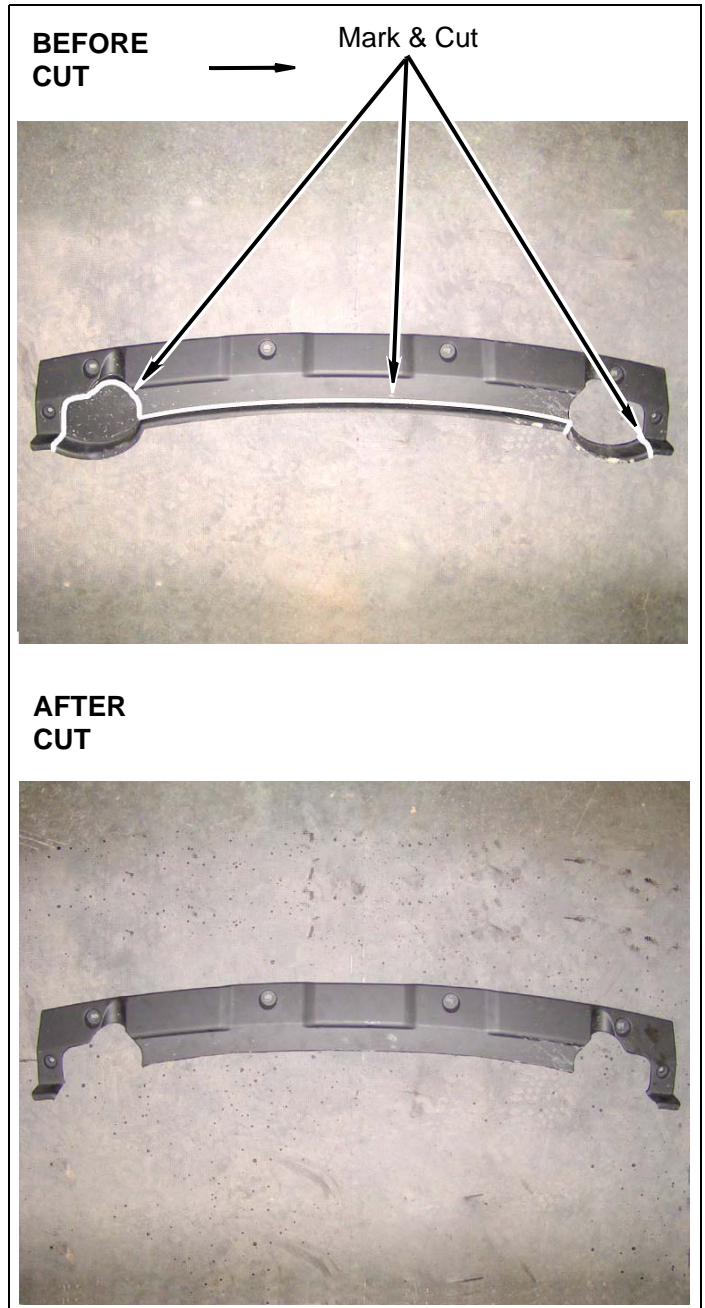

- b. Install lower fascia onto bumper with four screws and two bolts.

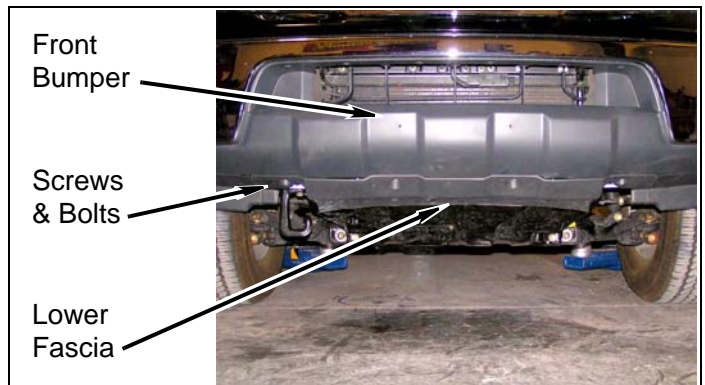

After Completing Installation

Inside Cab

1. Install airbag fuse and fuse cover.

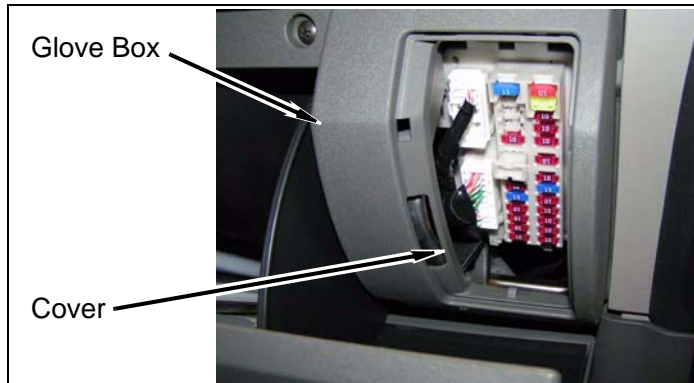

Engine Compartment

1. Install battery into vehicle with battery tie downs.
2. Connect both battery cables. Connect positive cable first, then negative cable.

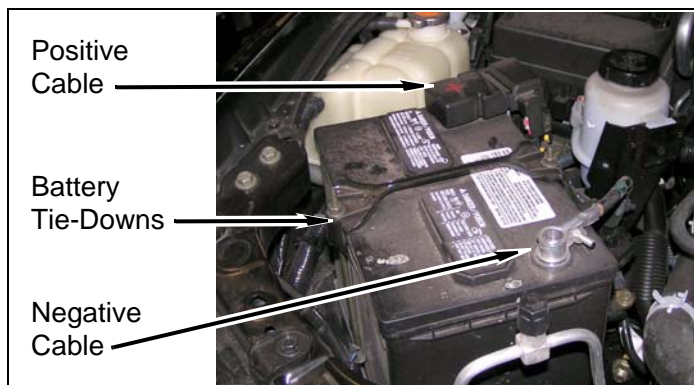

Miscellaneous

1. Apply **kit label** (warning) onto dashboard in plain sight of all vehicle occupants.
2. Check all fasteners to ensure they are tight.
3. Ensure all wires, hoses, cables, etc. are properly connected and there is ample slack.
4. Adjust headlights.

⚠ WARNING

If the engine cooling system is hot, the coolant will be **HOT** and **UNDER PRESSURE**. To prevent serious personal injury, wait until the cooling system is completely cool before removing the cap from the radiator.

5. Remove radiator cap. Start engine and top off cooling system. Purge air from cooling system according to vehicle owner's manual instructions. Install radiator cap.

Dynamic Vehicle Check

1. Check steering in both directions to ensure that there is no bind. Check operation of clutch, brake system, and parking brake. Check operation of transmission and transfer case. Ensure there is full engagement in all gears and 4WD ranges. Check battery connections and electrical component operations. Test-drive vehicle.

⚠ WARNING

Retorque all fasteners after 500 miles and after off road use. All body lift components should be visually inspected and fasteners retorqued during routine vehicle servicing.

⚠ CAUTION

Performance Automotive Group does not recommend any particular wheel and tire combinations for use with its body lifts and cannot assume responsibility for the customer's choice of wheels and tires. Refer to your owner's manual for recommended tire sizes and warnings related to the use of oversized tires. Larger wheel and tire combinations increase stress and wear on steering and suspension components, which leads to increased maintenance and higher risk for component failure. Larger wheel and tire combinations also alter speedometer calibration, braking effectiveness, center of gravity, and handling characteristics. Consult an experienced local off road shop to find what wheel and tire combinations work best with your vehicle.

NOTE

All warranty information, instruction sheets, and other documents regarding the installation of this product must be retained by the vehicle owner. Information contained in the instructions and on the warranty card will be required for any warranty claims. The vehicle owner needs to understand the modifications made to the vehicle and how they affect vehicle handling and performance. Failure to provide the customer with this information can result in damage to the vehicle and severe personal injury.

Accessories

Kit# 6423: Front & Rear Gap Guards

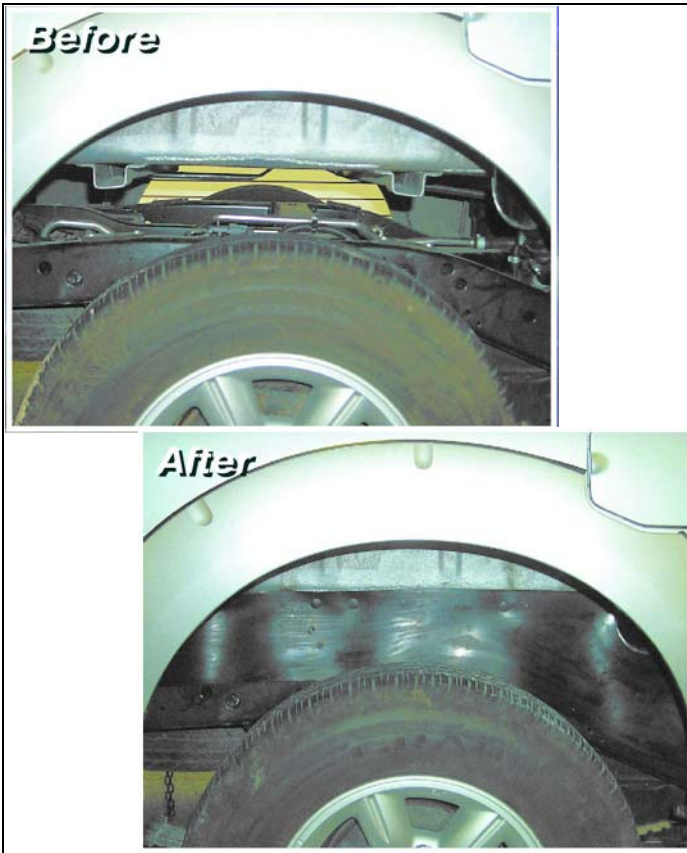

Kit Parts List

Qty.	Description
8	Block (3" x 2")
4	Block (3" x 3")
10	Bolt (1/2" x 1-1/2")
7	Bolt (1/4" x 1")
4	Bolt (10mm x 120mm)
8	Bolt (12mm x 180mm)
2	Bolt (12mm x 30mm)
1	Bolt (3/8" x 1-1/4")
6	Bolt (5/16" x 1")
1	Bolt (6mm x 30mm)
1	Bracket (2" step w/ stud)
3	Bracket (2" w/ stud)
1	Bracket (2" Z-shaped)
2	Bracket (2-1/2" C-shaped)
2	Bracket (3" w/ stud)
1	Bracket (front bumper, driver)
1	Bracket (front bumper, passenger)
1	Bracket (radiator, driver)
1	Bracket (radiator, passenger)
1	Bracket (rear bumper, driver)
1	Bracket (rear bumper, passenger)
2	Bracket (rear bumper, support)
2	Clamp (#10 hose)
2	Clamp (#20 hose)
1	Decal (bumper warning)
1	Decal (logo)
1	Decal (warning)
1	Extension (fuel filler)
1	Extension (shift, 5/8" x 3")
1	Extension (steering)
1	Hose (1" x 3")
1	Hose (5/8" x 14")
1	Loctite® (6ml bottle)
14	Nut (1/2" Nylock)
12	Nut (1/4" Nylock)
1	Spacer (.250")
6	Spacer (2" x 3" x 1")
4	Spacer (2" x 3" x 2")
6	Tie
6	U-nut (5/16")
6	Washer (1/2" SAE)
24	Washer (1/2" USS)
17	Washer (1/4" SAE)
2	Washer (12mm)
6	Washer (5/16" USS)

NOTE

Depending on the vehicle configuration (automatic or manual transmission, 2WD or 4WD, cab length, bed length, etc.), some parts may not be used.