

Installation Instructions

For Set # 3.4172

65-67 Chevrolet Biscayne, Bel Air,
Caprice & Impala Body Mounts
Includes Standard Wagon & Convertible



1131 VIA CALLEJON, SAN CLEMENTE, CA 92673

© 2022 Energy Suspension. All rights reserved.
May not be reproduced, in any form, or by any means,
without the written consent of Energy Suspension.

It is recommended that you refer to a qualified service center if you are unfamiliar with vehicle chassis and suspension repair work. This instruction is intended as a guideline for the safe installation of Energy Suspension polyurethane bushings after original equipment has been removed from the vehicle. Reference the vehicle manufacturer's service manual for component removal and replacement procedures and torque specifications. Before beginning work, read installation instructions and verify parts received match P/N's and quantities in the parts list. In the case of a discrepancy, contact Energy Suspension Customer Service (949-361-3935). Energy Suspension parts are designed to work with vehicles in a good state of repair. We cannot be held responsible for suspension or steering related problems occurring due to poor vehicle maintenance. Wheel alignment is altered when suspension components are removed and replaced. It is highly recommended that your vehicle is checked and adjusted by a qualified alignment shop prior to use.

PARTS LIST:

2 EA 04P04377	65-68 CORE SUPPORT UPPER	2 EA 15.03.13.39	1-3/4" X 7/16" X 1/8" FLAT WASHER
2 EA 04P04378	65-68 CORE SUPPORT LOWER	6 EA 15.03.28.39	2-1/2" X 3/4" X 1/8" FLAT WASHER
6 EA 04P04379	POS. 4 & 6 UPPER	1 EA 15.03.34.39	2-1/2" X 7/16" X 1/8" FLAT WASHER CLIPPED
6 EA 04P04380	POS. 4 & 6 LOWER	4 EA 15.03.49.39	2-1/4" X 1/2" X .132" FLAT WASHER
2 EA 04P04381	POS. 3 & 5 UPPER (CONV. & WAGON)	6 EA 15.03.85.39	1-3/8" X .15/32" X 3/16" FLAT WASHER
4 EA 04P04392	POS. 1 & 2 UPPER (65-66)	14 EA 15P0314942	1" X 15/32 X 1/8" FLAT WASHER
4 EA 04P04393	POS. 1 & 2 LOWER (65-67)	10 EA 15.05.08.39	7/16-14 X 3" BOLT
4 EA 04P04394	POS. 2 UPPER (67)	6 EA 15.05.54.39	7/16-14 X 2-1/2" BOLT
2 EA 04P04395	POS. 7 UPPER	2 EA 15.07.02.40	7/16-14 LOCK NUT
2 EA 04P04396	POS. 7 LOWER	4 EA 15P0704342	7/16-14 FLANGED HEX NUT
1 EA 17P17699	INSTALLATION INSTRUCTIONS	2 EA 15.10.03.39	3/4" X 1/2" X 1-7/16" SLEEVE
5 EA 15.03.07.39	2-1/2" X 7/16" X 1/8" FLAT WASHER	4 EA 15.10.40.39	7/8" X 5/8" X 1-1/2" SLEEVE
14 EA 15.03.09.39	2" X 7/16" X 1/8" FLAT WASHER	6 EA 15.10.59.39	7/8" X 3/4" X 1-1/2" SLEEVE
		2 EA 15P1071939	3/4" X 9/16" X 1-5/32" SLEEVE

Read this instruction sheet thoroughly before initiating any work!

NOTE: Variances may exist between your vehicle's construction and the mount position diagrams shown in these instructions. In the 1960's, vehicle assembly lines would sometimes use up inventory from the previous model year, or use a substitute part from another vehicle line if inventory ran out. There were also mid-year design changes. For these reasons, it is impractical for us to show every combination of body mount installed at the time of manufacture. This body mount set has enough bushings to cover almost every vehicle configuration. If you find that the mounts fit better when used in a different order than as depicted, then use your discretion to best accommodate your vehicle's unique fitment requirements. Furthermore, you may prefer to fit a mount in every frame position even if your vehicle didn't come that way originally.

REMOVAL ORDER: Remove both bumpers (Pic. 1). Remove battery and battery tray. Remove both front inner fender panels to gain access to positions 1 & 2 body mounts (Pic. 2). Remove steering coupler rag joint (Pics. 3 & 4). Remove parking brake cable stud adjusting nut from equalizer and remove retaining clip at inner frame between positions 1 & 2 driver side (Pic. 5). Remove ground strap from body to inner frame near position 2 passenger side (Pic. 6). Replace all items removed at completion of work.

CAUTION: Only remove body mount bolts from one side of vehicle. (Except sedan position # 5 body mount bolt must be removed from both sides). Just loosen body mount bolts on opposite side of vehicle. Raise side of vehicle body with bolts removed just high enough to remove/replace mounts. When removing O.E. body mounts, be sure to note number and position of any shims that may have been used to align body. These shims must be reused in their original positions to retain proper body alignment. Always keep doors shut and maintain a watchful eye on the fan shroud, brake lines, shift linkage and various hoses for sufficient clearance when raising body. Never place jack cradle directly against body panels; instead use 2x4 wooden blocks or equivalent to spread jack force. Good places for body jack points are just behind front fender well and just in front of rear fender well. On wagons, a 3rd jack may also be needed behind rear fender well. Always jack body evenly, avoiding one jack lifting more than others. When upper mounts are installed and body is resting on them, check to see if any upper mounts are loose. If so, additional shims may be needed (not included in this set) to take up the gap. Torque all bolts to factory specifications (sometimes a little extra torque is needed to bottom out bolt on inner sleeve).

RUST: Older vehicles are likely to have rust. This kit includes loose hex nuts but no captured style nuts. If one or more bolts snap off or threads strip out during their removal, you may need to cut open body panel/s to access and replace captured nut/s. Other issues you may find are circular rust areas on frame or frame perches corresponding to old rubber body mount diameters, or rusted metal rings within original rubber body mounts sticking to frame perches and blocking bolt holes. In more severe cases, frame perch replacement may be necessary.

Installation Instructions

For set # 3.4172

65-67 Chevrolet Biscayne, Bel Air,
Caprice & Impala Body Mounts
Includes Standard Wagon & Convertible

ENERGY
SUSPENSION 

1131 VIA CALLEJON, SAN CLEMENTE, CA 92673

© 2022 Energy Suspension. All rights reserved.
May not be reproduced, in any form, or by any means,
without the written consent of Energy Suspension.

1

Removal of front and rear bumpers is necessary for proper clearance when lifting body.

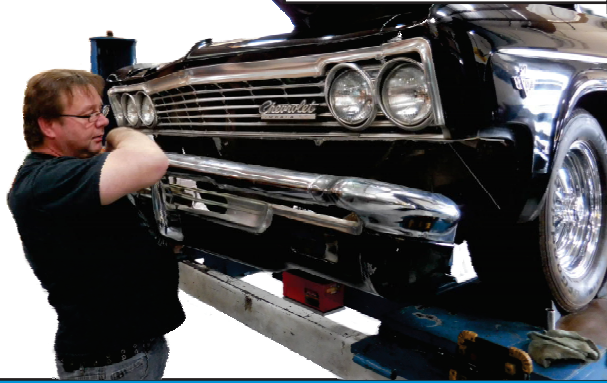

2

Remove fender wells from both sides. There is about 10 to 15 bolts that thread into J-Nuts. Spray with penetrating oil and be prepared for some nuts to break free and spin. Its almost impossible to get to back side to hold nuts. Use an angle grinder to grind off head of bolts .

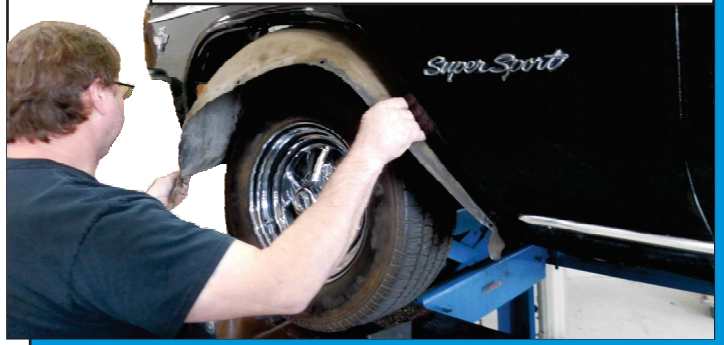

3

After removing nuts securing rag joint, remove 2 nuts from bracket that holds steering column. Lower steering column and pull back a few inches for clearance when lifting body. (See Pic. 4)



4

With fender well removed you have better access to rag joint at steering box.



5

Remove parking brake slack adjuster bracket (above) and retaining clip (below) holding parking brake cable to inside of frame between POS. 1 & 2 body mounts.

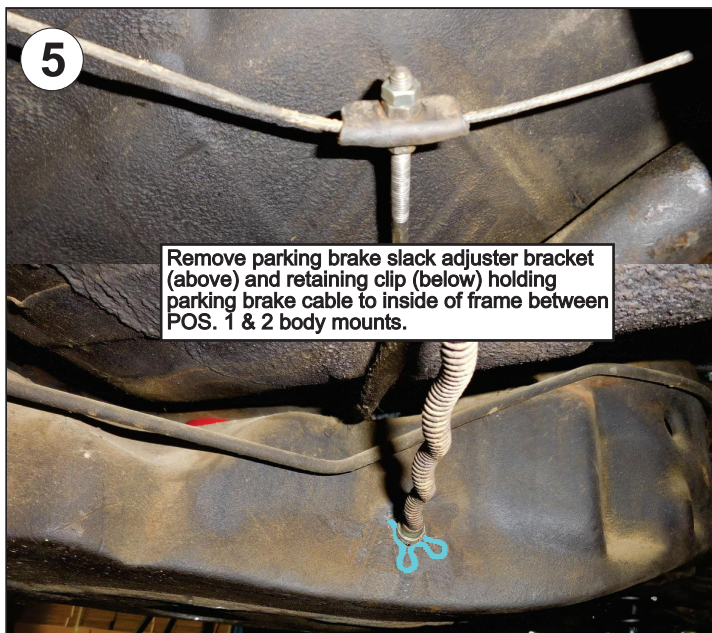

6

Remove ground strap from body to frame from passenger side located inside frame next to POS. 2 body mount.



Installation Instructions

For set # 3.4172

65-67 Chevrolet Biscayne, Bel Air,
Caprice & Impala Body Mounts
Includes Standard Wagon & Convertible

1131 VIA CALLEJON, SAN CLEMENTE, CA 92673

© 2022 Energy Suspension. All rights reserved.
May not be reproduced, in any form, or by any means,
without the written consent of Energy Suspension.

Mount Position Diagram

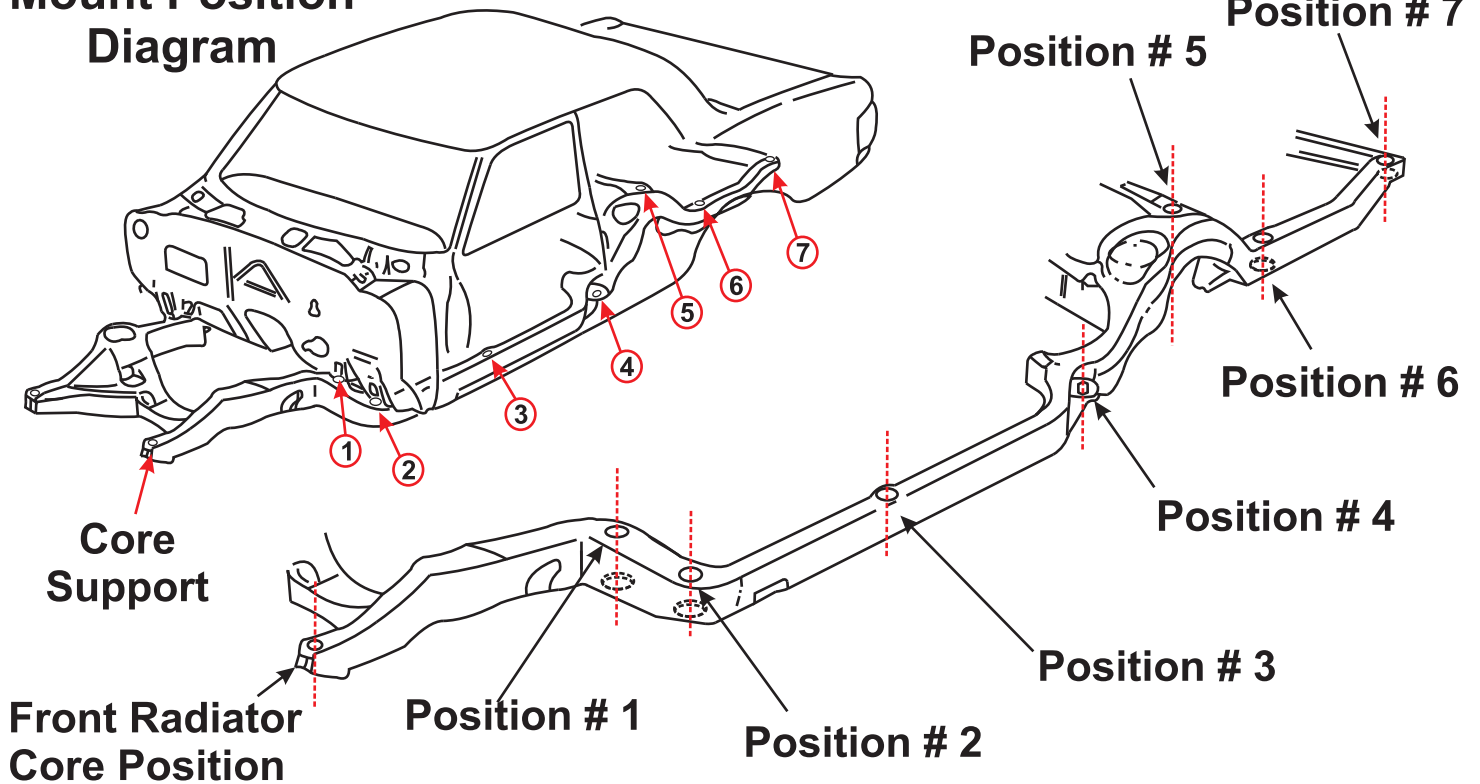

CORE SUPPORT

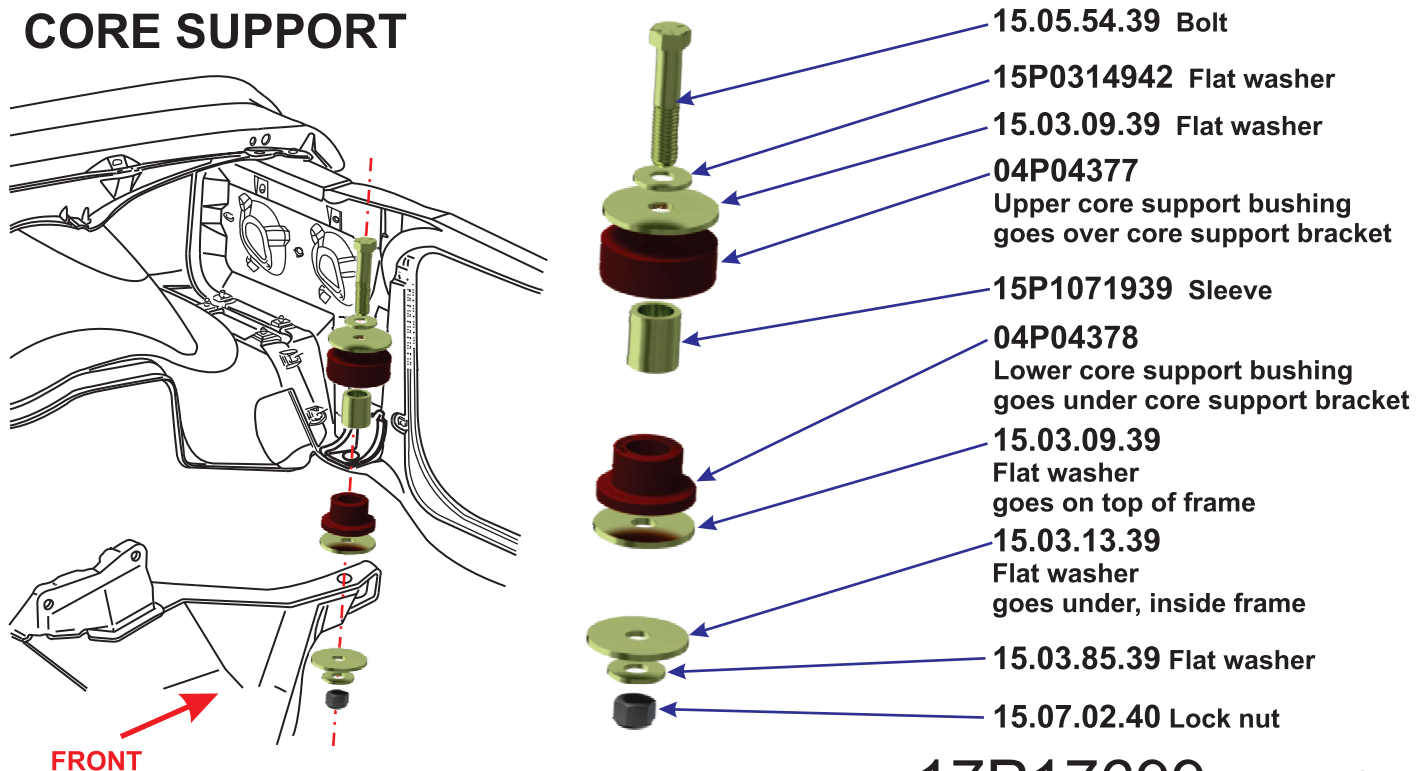

Installation Instructions

For set # 3.4172

65-67 Chevrolet Biscayne, Bel Air,
Caprice & Impala Body Mounts
Includes Standard Wagon & Convertible



1131 VIA CALLEJON, SAN CLEMENTE, CA 92673

© 2022 Energy Suspension. All rights reserved.
May not be reproduced, in any form, or by any means,
without the written consent of Energy Suspension.

1965 & 1966 POSITIONS 1, 2 & 3

15P0704342

7/16-14 Flanged hex nut
replacement for O.E. caged
nut if needed.

15.03.85.39 Washer
Goes under flanged hex
nut inside body

15.03.34.39
Clipped Washer
Driver side only
15.03.07.39
Passenger side.

04P04392
Bushing

15.03.07.39
Washer

15.03.28.39
Washer

15.10.40.39
Sleeve

04P04393
Bushing

Position # 2

04P04379
Bushing

15.10.59.39
Sleeve

15.03.49.39
Washer

15P0314942
Washer

15.05.08.39
Bolt

Core
Position

Position # 1

15P0314942
Washer

15.05.54.39
Bolt

****Position # 3 NOTE****
MOUNT NOT USED
1965 Caprice
4-Door Hardtop

Position # 3
1965 Convertible Only
1966 Convertible Only

****Position #1 NOTE****
Drivers Side, the clipped
area on washer must be
placed toward firewall to
clear the angled area.

1967 POSITIONS 1, 2 & 3

15P0704342

7/16-14 Flanged hex nut
replacement for O.E. caged
nut if needed.

15.03.85.39 Washer
Goes under flanged hex
nut inside body

15.03.34.39
Clipped Washer
Driver side only
15.03.07.39
Passenger side

04P04392
Bushing

****Position #1 NOTE****
Drivers Side, the clipped
area on washer must be
placed toward firewall to
clear the angled area.

Position # 3
Upper Only
Convertible
04P04394
Bushing

Position # 2
Upper Only
04P04394
Bushing

15.10.40.39
Sleeve

04P04393
Bushing

15.03.49.39
Washer

15.05.08.39
Bolt

15P0314942
Washer

Core
Position

Position # 1

17P17699 Page 4 of 7

Installation Instructions

For set # 3.4172

65-67 Chevrolet Biscayne, Bel Air,
Caprice & Impala Body Mounts
Includes Standard Wagon & Convertible

1131 VIA CALLEJON, SAN CLEMENTE, CA 92673

© 2022 Energy Suspension. All rights reserved.
May not be reproduced, in any form, or by any means,
without the written consent of Energy Suspension.

1966 POSITIONS 4, 5, 6 & 7

POS. # 5

MOUNT NOT USED

1966 Impala 2 door Coupe (L6/V8)

1966 Impala 4 door Hardtop (sports sedan) (L6/V8)

1966 Caprice 4 door Hardtop (V8)

1966 Caprice 2 door Custom coupe(V8)

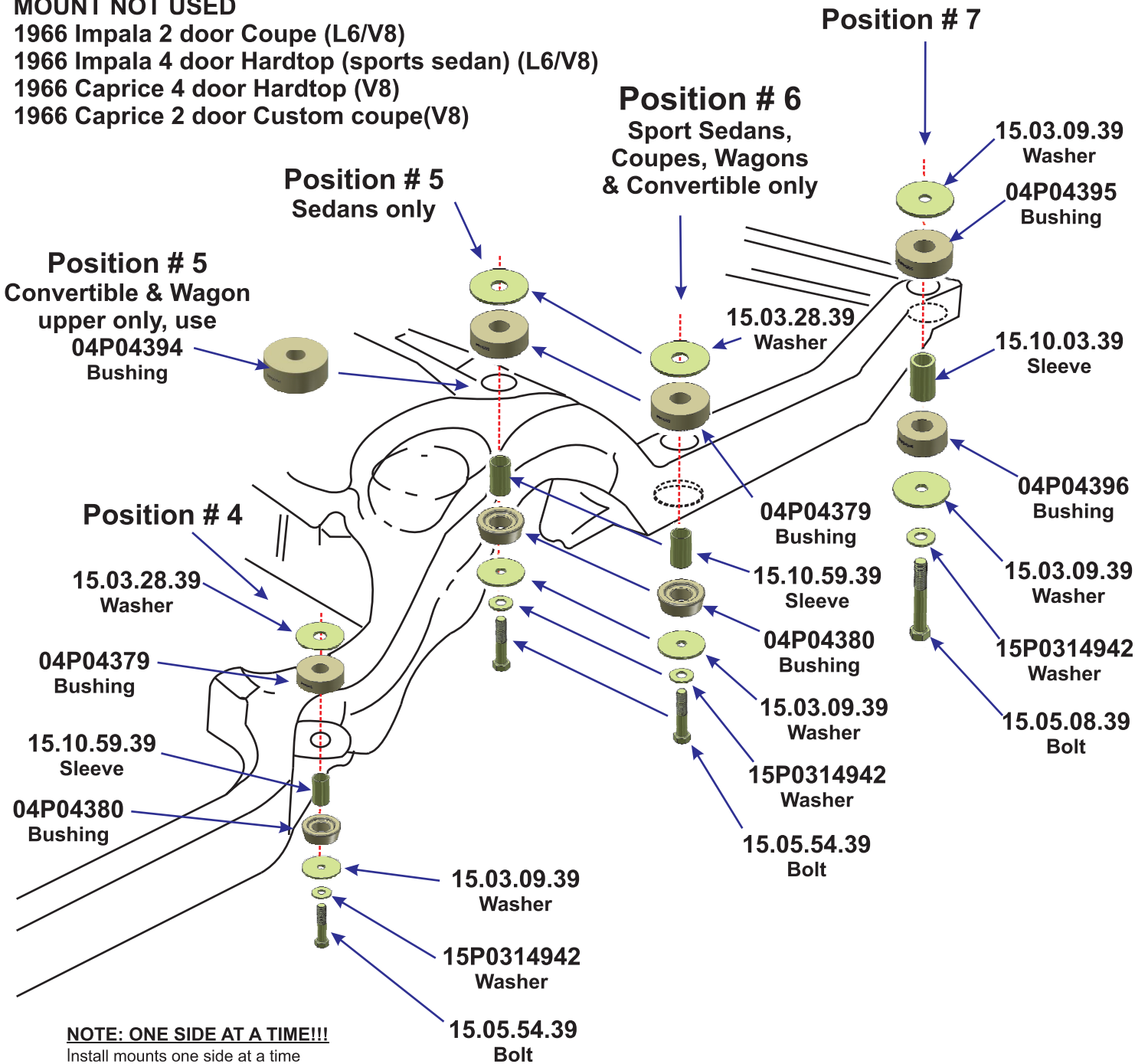

NOTE: ONE SIDE AT A TIME!!!

Install mounts one side at a time
with bolts on other side loosened
only (Sedans only must have
position # 5 body mount bolt
removed from both sides).

Installation Instructions

For set # 3.4172

65-67 Chevrolet Biscayne, Bel Air,
Caprice & Impala Body Mounts
Includes Standard Wagon & Convertible



1131 VIA CALLEJON, SAN CLEMENTE, CA 92673

© 2022 Energy Suspension. All rights reserved.
May not be reproduced, in any form, or by any means,
without the written consent of Energy Suspension.

1967 POSITIONS 4, 5, 6 & 7

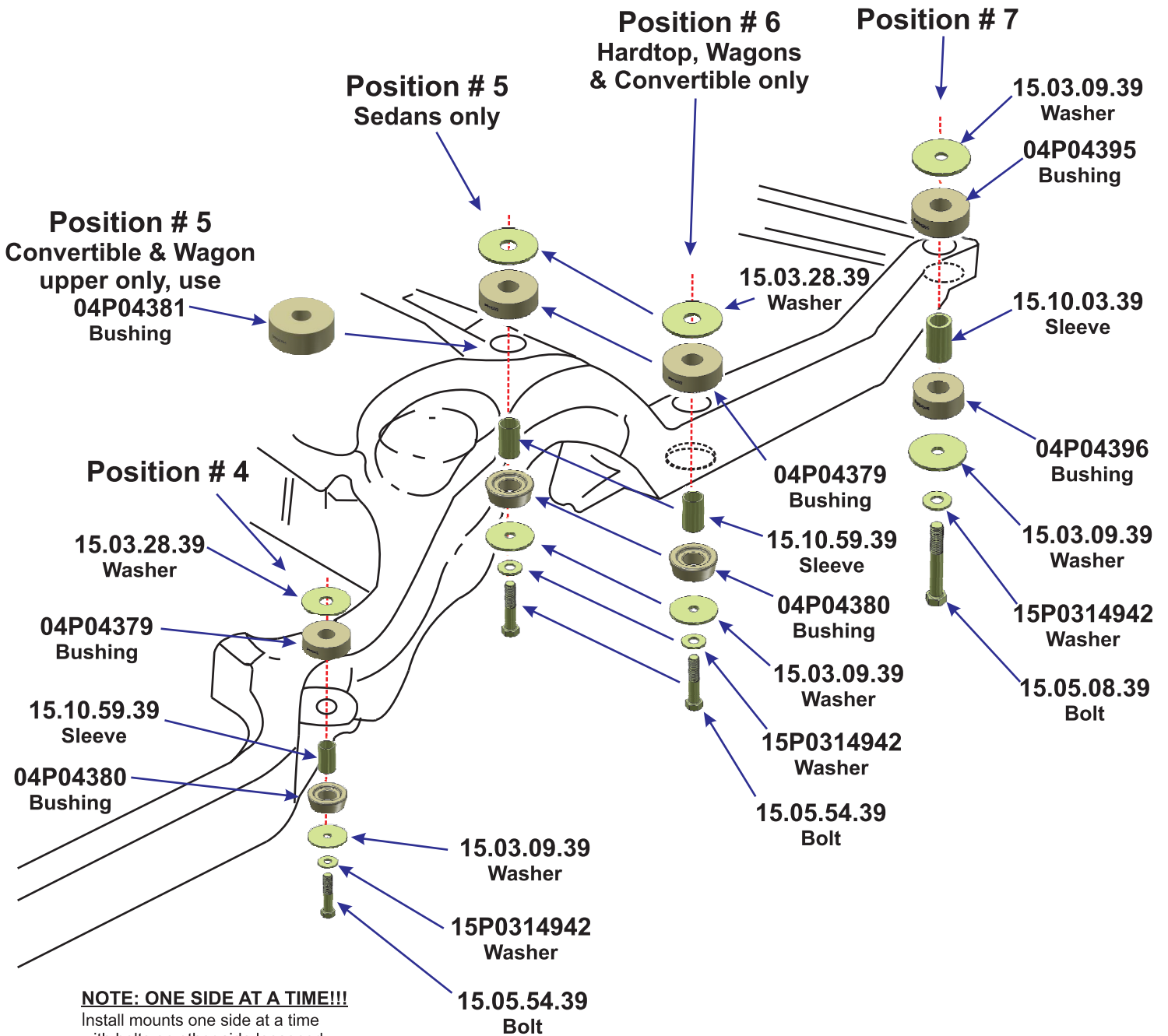

NOTE: ONE SIDE AT A TIME!!!

Install mounts one side at a time with bolts on other side loosened only (Sedans only must have position # 5 body mount bolt removed from both sides).